

15 W auxiliary power supply for invertized air-conditioner using ICE5AR4770AG

REF_5AR4770AG_15W1

About this document

Scope and purpose

This document is a reference design for a 15 W auxiliary power supply for an invertized air-conditioner unit with the latest Infineon fifth-generation Fixed-Frequency (FF) CoolSET™ [ICE5AR4770AG](#). The power supply is designed with a universal input compatible with most geographic regions and two outputs (+12 V/1 A isolated, +15 V/150 mA non-isolated) on a single-layer PCB. The PCB has a provision to add a linear regulator to support a third output (e.g. +5 V), which is connected to a +12 V output.

Highlights of the auxiliary power supply for the invertized air-conditioner unit are:

- Tightly regulated output voltages, high efficiency under light load and low standby power
- Comprehensive protection feature CoolSET™ with integrated input Line Over Voltage Protection (LOVP) and externally implemented brown-in protection (GATE pin resistor to GND)
- Auto-restart protection scheme to minimize interruption and enhance end-user experience

Intended audience

This document is intended for power supply design engineers who are designing auxiliary power supplies for invertized air-conditioner units that are efficient, reliable and easy to design.

Table of contents

About this document	1
Table of contents	1
1 System introduction	3
2 Reference board design	5
3 Power supply specifications	6
4 Circuit diagram	7
5 Circuit description	8
5.1 EMI filtering and line rectification.....	8
5.2 Flyback converter power stage.....	8
5.3 Control of flyback converter through fifth-generation FF CoolSET™ ICE5AR4770AG.....	8
5.3.1 Current sensing	8
5.3.2 Feedback and compensation network.....	8
5.4 Unique features of the fifth-generation FF CoolSET™ ICE5AR4770AG	9
5.4.1 Fast self-start-up and sustaining of V_{CC}	9
5.4.2 CCM, DCM operation with frequency reduction.....	9
5.4.3 Frequency jittering with modulated gate drive	9
5.4.4 System robustness and reliability through protection features	10
5.5 Clamper circuit	10
5.6 PCB design tips.....	10
5.7 EMI reduction tips	11

System introduction

6	PCB layout.....	12
6.1	Top side	12
6.2	Bottom side	12
7	BOM.....	13
8	Transformer specification	15
9	Measurement data and graphs.....	16
9.1	Efficiency curve.....	17
9.2	Standby power	18
9.3	Line and load regulation	18
9.4	Maximum input power	19
9.5	Frequency reduction	19
9.6	ESD immunity (EN 61000-4-2).....	20
9.7	Surge immunity (EN 61000-4-5).....	20
9.8	Conducted emissions (EN 55022 class B)	21
9.9	Thermal measurement	22
9.10	+18 V rail regulation (LDO input).....	23
10	Waveforms and oscilloscope plots.....	24
10.1	Start-up at full load	24
10.2	Soft-start at full load	24
10.3	Drain and CS voltage at full load	25
10.4	Frequency jittering and modulated gate drive at full load.....	25
10.5	Load-transient response (dynamic load from minimum to full load).....	26
10.6	Output ripple voltage at full load	26
10.7	Output ripple voltage at ABM (minimum load).....	27
10.8	Entering ABM	27
10.9	During ABM	28
10.10	Leaving ABM	28
10.11	V _{CC} OV/UV protection	29
10.12	Over-load protection.....	29
10.13	Brown-in and LOVP	30
11	Appendix A: Transformer design and spreadsheet [3]	31
12	Appendix B: WE transformer specification	40
13	References	41
	Revision history.....	42

1 System introduction

With the growing household trend for internet-connected devices, the new generation of home appliances including air-conditioners are equipped with advanced features such as wireless control and monitoring capability, smart sensors and touch screen display. These can transform a static product into an interactive and intelligent home appliance, capable of adapting to the smart-home theme. To support this trend, Infineon has introduced the latest fifth-generation FF CoolSET™ to address this need in an efficient and cost-effective manner.

An auxiliary SMPS is needed to power the various modules and sensors, which typically operate from a stable DC voltage source. The Infineon CoolSET™ (as shown in Figure 1) forms the heart of the system, providing the necessary protection and AC-DC conversion from the mains to multiple regulated DC voltages to power the various blocks.

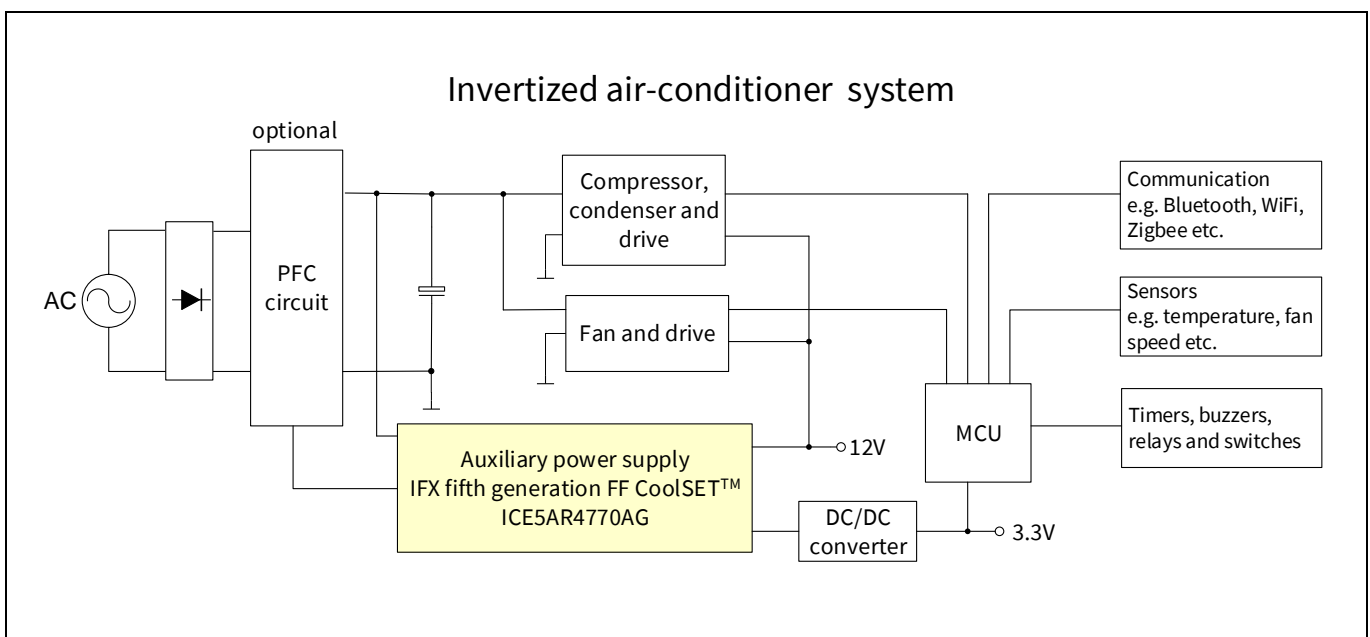

Figure 1 Simplified outdoor air-conditioner unit system block diagram example

Table 1 lists the system requirements for auxiliary power supply for the invertized air-conditioner unit, and the corresponding Infineon solution is shown in the right-hand column.

Table 1 System requirements and Infineon solutions

	System requirement for invertized air-conditioner unit power supply	Infineon solution – ICE5AR4770AG
1	High efficiency under light load and low standby power	New FF control and Active Burst Mode (ABM)
2	Robust system and protection features	Comprehensive protection feature CoolSET™ in DSO-12 package with integrated LOVP and externally implemented brown-in protection
3	Auto-restart protection scheme to minimize interruption and enhance end-user experience	All protections are in auto-restart

System introduction

1.1 High efficiency under light load and low standby power

During typical air-conditioner operation, the power requirement fluctuates according to various use cases. However, in most cases where room temperature is already stabilized, the indoor and outdoor air-conditioner units will reside in an idle state, in which the loading toward the auxiliary power supply is low. It is crucial that the auxiliary power supply operates as efficiently as possible, because it will be in this particular state for most of the period. Under light-load conditions, losses incurred with the power switch are usually dominated by the switching operation. The choice of switching scheme and frequency play a crucial role in ensuring high conversion efficiency.

In this reference design, ICE5AR4770AG was primarily chosen due to its frequency reduction switching scheme. Compared with a traditional FF flyback, the CoolSET™ reduces its switching frequency from medium to light load, thereby minimizing switching losses. Therefore, an efficiency of more than 80 percent is achievable under 25 percent loading conditions and nominal input voltages.

1.2 Simplified circuitry with good integration of power and protection features

To relieve the designer of the complexity of PCB layout and circuit design, the CoolSET™ is a highly integrated device with both a controller and a HV MOSFET integrated into a single, space-saving DSO-12 package. These certainly help the designer to reduce component count as well as simplifying the layout into a single-layer PCB design for ease of manufacturing, using the traditional cost-effective wave-soldering process.

The various protection features of the CoolSET™, such as integrated LOVP and externally implemented brown-in protection, boost the reliability of the power supply.

1.3 Auto-restart protection scheme to minimize interruption and enhance end-user experience

For an invertized air-conditioner unit, it would be annoying to both the end-user and the manufacturer if the system were to halt and latch after protection. Accessibility of the input AC plug may also be difficult; therefore, to minimize interruption, the CoolSET™ implements auto-restart mode for all abnormal protections.

15 W auxiliary power supply for invertized air-conditioner using ICE5AR4770AG

Reference board design

2 Reference board design

This document provides complete design details including specifications, schematics, Bill of Materials (BOM), PCB layout, and transformer design and construction information. Performance results pertaining to line/load regulation, efficiency, transient load, thermal conditions, conducted EMI scans and so on are also included.

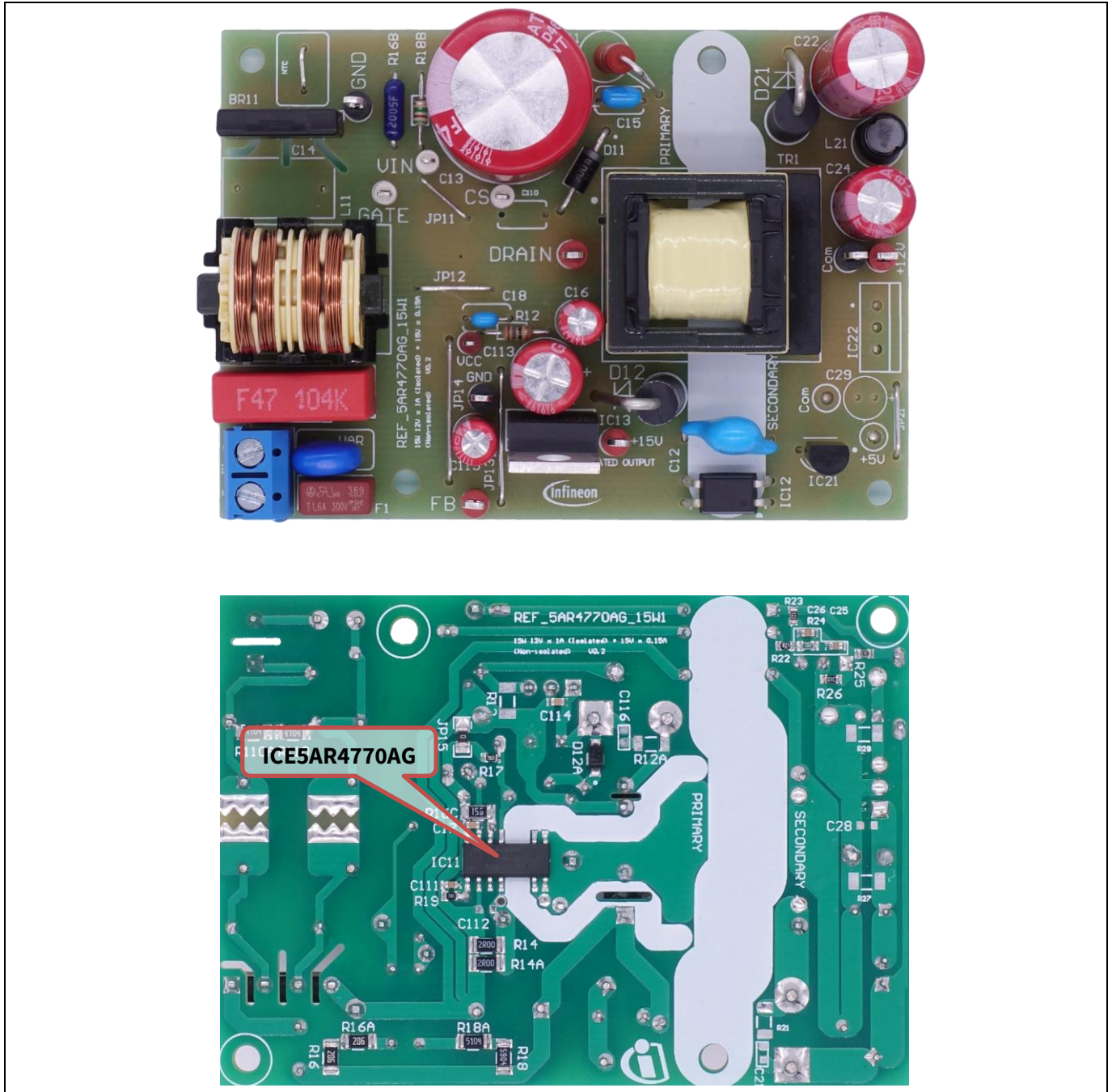

Figure 2 REF_5AR4770AG_15W1

15 W auxiliary power supply for invertized air-conditioner using ICE5AR4770AG



Power supply specifications

3 Power supply specifications

The table below shows the minimum acceptance performance of the design at 25°C ambient temperature. Actual performance is listed in the measurements section.

Table 2 Specifications of REF_5AR4770AG_15W1

Description	Symbol	Min.	Type	Max.	Units	Comments
Input						
Voltage	V_{IN}	85	-	264	V AC	2 wires (no P.E.)
Frequency	f_{LINE}	47	50/60	64	Hz	
No-load input power	P_{stby_NL}	-	-	100	mW	
630 mW load input power	P_{stby_ML}	-	-	1	W	
Brown-in	V_{BI}	-	75	-	V AC	
LOVP	V_{LOVP}	-	300	-	V AC	
Output						
Output voltage 1	V_{OUT1}	-	12	-	V	±1 percent
Output current 1	I_{OUT1}	-	-	1	A	
Output voltage ripple 1	$V_{RIPPLE1}$	-	-	100	mV	±1 percent
Output voltage 2	V_{OUT2}	-	15	-	V	
Output current 2	I_{OUT2}	-	-	0.15	A	
Output voltage ripple 2	$V_{RIPPLE2}$	-	-	100	mV	
Output power	P_{OUT_Nom}	-	14.25	-	W	
Output over-current protection (+12 V)	I_{OCP}	-	1.50	-	A	0.15 A load on +15 V
Start-up time	t_{start_up}	-	-	350	ms	
Efficiency						
Maximum load	η	83	-	-	%	115 V AC/220 V AC
Average efficiency (25 percent, 50 percent, 75 percent, 100 percent)	η_{avg}	83	-	-	%	115 V AC/220 V AC
Environmental						
Conducted EMI			8		dB	Margin, CISPR 22 class B EN 61000-4-2 EN 61000-4-5
ESD			±8		kV	
Surge immunity						
Differential mode			±2		kV	
Common mode			±4		kV	
PCB dimension			57 x 80 x 30		mm ²	L x W x H (single-layer PCB)

4 Circuit diagram

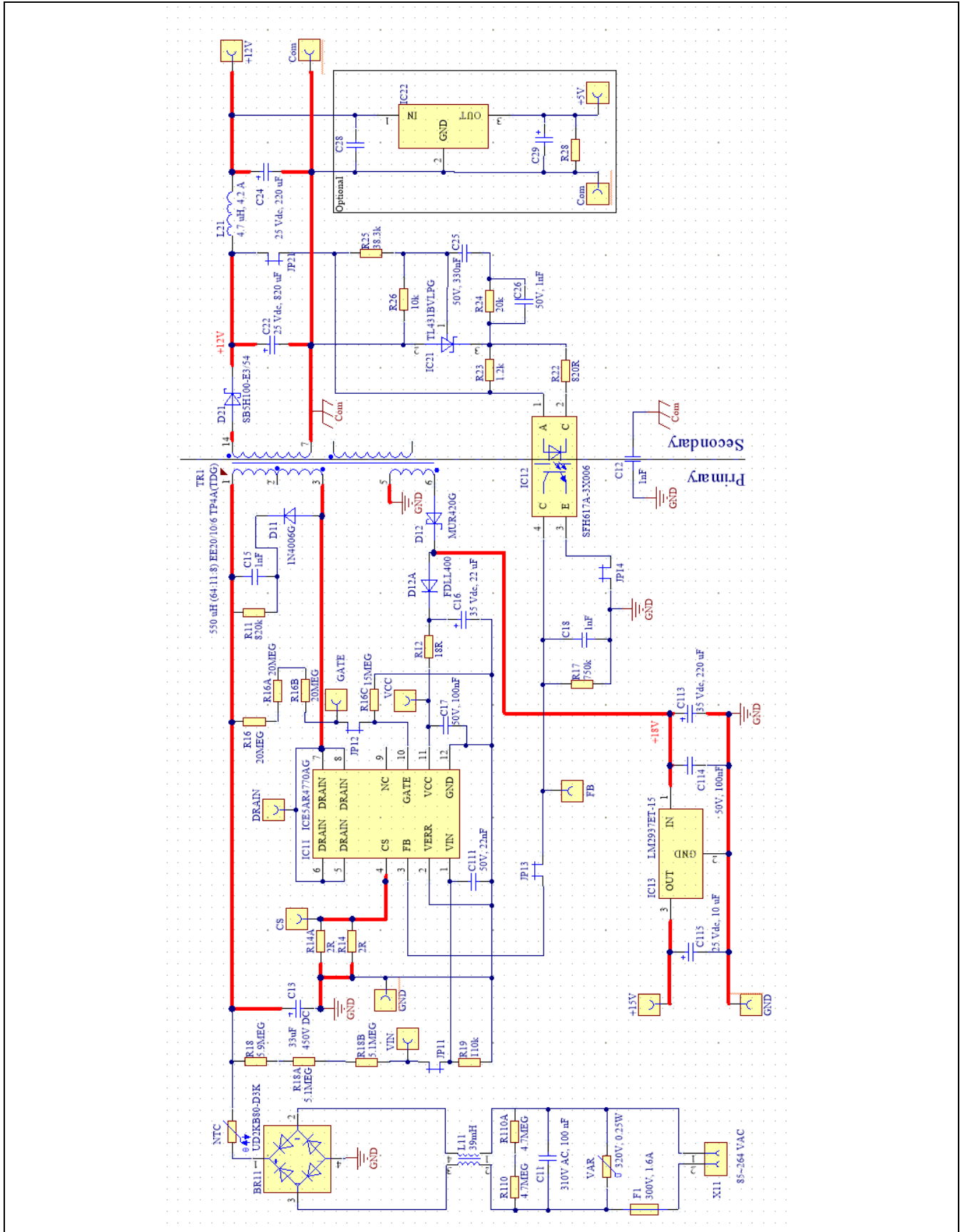

Figure 3 Schematic of REF_5AR4770AG_15W1

5 Circuit description

In this section, the design circuit for the SMPS unit will be briefly described by the different functional blocks. For details of the design procedure and component selection for the flyback circuitry please refer to the IC design guide [2] and calculation tool [3].

5.1 EMI filtering and line rectification

The input of the power supply unit is taken from the AC power grid, which is in the range of 85 V AC ~ 264 V AC. The fuse F1 is directly connected to the input line to protect the system in case of excess current entering the system circuit due to any fault. Following is the varistor VAR, which is connected across the input to absorb excessive energy during line-surge transient. The X-capacitor C11 and Common Mode Choke (CMC) L11 reduce the EMI noise. R110 and R110A serve as the X-capacitor discharge resistor. The bridge rectifier BR11 rectifies the AC input into DC voltage, filtered by the bulk capacitor C13.

5.2 Flyback converter power stage

The flyback converter power stage consists of transformer TR1, CoolSET™, secondary rectification diodes D21 and D12, secondary output capacitors C22 and C113 and output filter inductor L21.

When the primary HV MOSFET turns on, energy is stored in the transformer. When it turns off, the stored energy is discharged to the output capacitors and into the output load.

Secondary winding is sandwiched between two layers of primary winding to reduce leakage inductance. This improves efficiency and reduces voltage spikes.

For the output rectification, lower forward voltage and ultra-fast recovery diodes can improve efficiency. Capacitor C22 stores the energy needed during output load jumps. LC filter L21/C24 reduces the high-frequency ripple voltage.

The +15 V output is from the 15 V Low Drop-Out (LDO) regulator (IC13) with an input of +18 V. As such, this output should not be affected by cross-regulation. However, its input should be maintained within the operating range of the LDO.

5.3 Control of flyback converter through fifth-generation FF CoolSET™ ICE5AR4770AG

5.3.1 Current sensing

The ICE5AR4770AG is a current mode controller. The primary peak current is controlled cycle-by-cycle through the Current Sense (CS) resistors R14 and R14A in the CS pin (pin 4). Transformer saturation can be avoided through Peak Current Limitation (PCL); therefore, the system is more protected and reliable.

5.3.2 Feedback and compensation network

Resistor R25 is used to sense the V_{OUT} and feedback (FB) to the reference pin (pin 1) of error amplifier IC21 with reference to the voltage at resistor R26. A type 2 compensation network C25, C26 and R24 is connected between the output pin (pin 3) and the reference pin (pin 1) of the IC21 to stabilize the system. The IC21 further connects to pin 2 of the optocoupler (IC12) with a series resistor R22 to convert the control signal to the primary side through the connection of pin 4 of the IC12 to ICE5AR4770AG FB pin (pin 3) and complete the control loop. Both the optocoupler IC12 and the error amplifier IC21 are biased by V_{OUT} ; IC12 is a direct connection while IC21 is through an R23 resistor.

Circuit description

The FB pin of ICE5AR4770AG is a multi-function pin, which is used to select the entry burst power level (there are three levels available) through the resistor at the FB pin (R17) and also the burst-on/burst-off sense input during ABM.

5.4 Unique features of the fifth-generation FF CoolSET™ ICE5AR4770AG

5.4.1 Fast self-start-up and sustaining of V_{CC}

The IC uses a cascode structure to fast-charge the V_{CC} capacitor. Pull-up resistors R16, R16A and R16B connected to the GATE pin (pin 10) are used to initiate the start-up phase. At first, 0.2 mA is used to charge the V_{CC} capacitor from 0 V to 1.1 V. This is a protection which reduces the power dissipation of the power MOSFET during V_{CC} short-to-GND condition. Thereafter, a much higher charging current of 3.2 mA will charge the V_{CC} capacitor until the V_{CC_ON} is reached. Start-up time of less than 250 ms is achievable with a V_{CC} capacitor of 22 μ F.

After start-up, the IC V_{CC} supply is usually sustained by the auxiliary winding of the transformer, which needs to support the V_{CC} to be above Under Voltage Lockout (UVLO) voltage (10 V typ.). In this reference board, the V_{CC} supply is tapped from the +15 V winding.

5.4.2 CCM, DCM operation with frequency reduction

ICE5AR4770G can be operated in either Discontinuous Conduction Mode (DCM) or Continuous Conduction Mode (CCM) with frequency-reduction features. This reference board is designed to operate in DCM at operating input voltage and load conditions. When the system is operating at high output load, the controller will switch at 100 kHz fixed frequency. In order to achieve a better efficiency between light load and medium load, frequency reduction is implemented as a function of V_{FB} , as shown in Figure 4. Switching frequency will not reduce further once the minimum switching frequency of 43 kHz is reached.

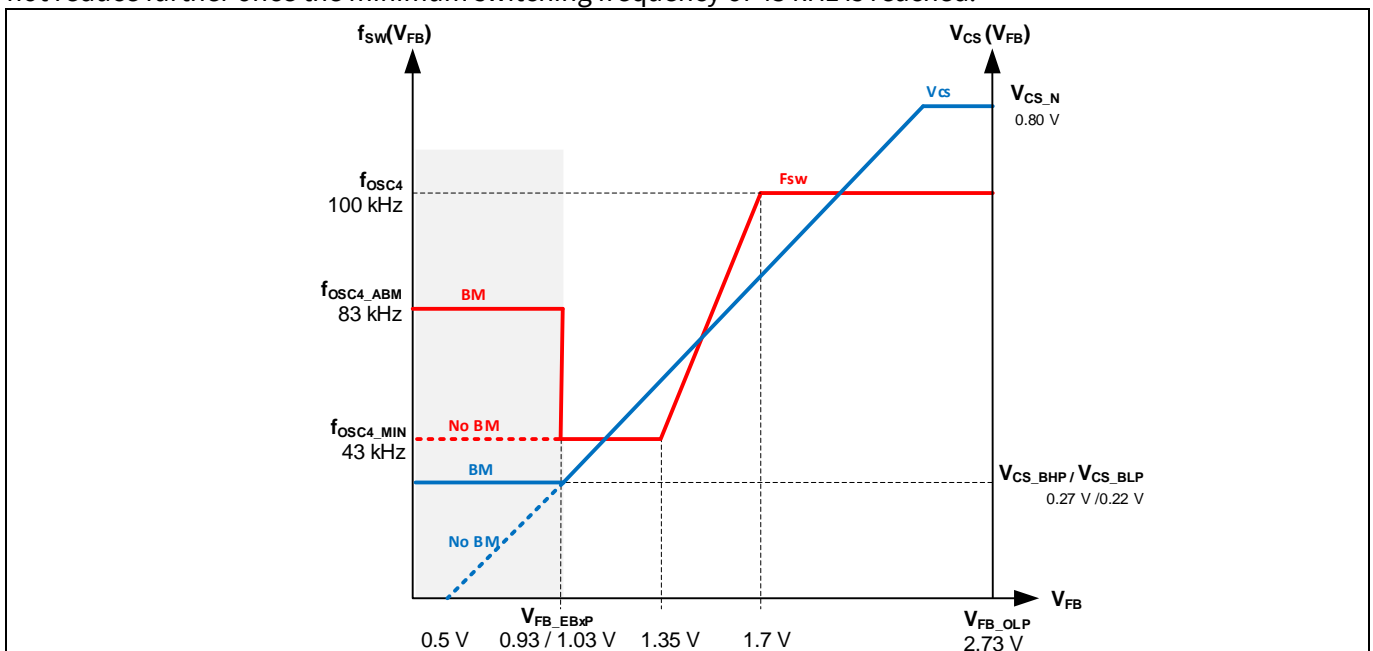

Figure 4 Frequency-reduction curve

5.4.3 Frequency jittering with modulated gate drive

The ICE5AR4770AG has a frequency jittering feature with modulated gate drive to reduce the EMI noise. The jitter frequency is internally set at 100 kHz (± 4 kHz), and the jitter period is 4 ms.

Circuit description

5.4.4 System robustness and reliability through protection features

Protection is one of the major factors in determining whether the system is safe and robust – therefore sufficient protection is necessary. ICE5AR4770AG provides comprehensive protection to ensure the system is operating safely. This includes V_{IN} LOVP, V_{CC} OV and UV, over-load, over-temperature and V_{CC} short-to-GND. When those faults are found, the system will enter into protection mode. Once the fault is removed, the system resumes normal operation. A list of protections and the failure conditions is shown in the table below.

Table 3 Protection functions of ICE5AR4770AG

Protection function	Failure condition	Protection mode
V_{CC} OV	V_{VCC} greater than 25.5 V	Odd-skip auto-restart
V_{CC} UV	V_{VCC} less than 10 V	Auto-restart
V_{IN} LOVP	V_{VIN} greater than 2.85 V	Non-switch auto-restart
Over-load	V_{FB} greater than 2.73 V and lasts for 54 ms	Odd-skip auto-restart
Over-temperature	T_J greater than 140°C (40°C hysteresis)	Non-switch auto-restart
V_{CC} short-to-GND ($V_{VCC} = 0$ V, start-up = 50 M Ω and $V_{DRAIN} = 90$ V)	V_{VCC} less than 1.1 V, $I_{VCC_Charge1} \approx -0.2$ mA	Cannot start up

5.5 Clamper circuit

A clamper network consisting of D11, C15 and R11 is used to reduce the switching voltage spikes across the DRAIN of the integrated HV MOSFET of the CoolSET™, which are generated by the leakage inductance of the transformer TR1. This is a dissipative circuit; therefore, R11 and C15 need to be fine-tuned depending on the voltage derating factor and efficiency requirement.

5.6 PCB design tips

For a good PCB design layout, there are several points to note.

- The switching power loop needs to be as small as possible (see Figure 5). There are three power loops in the reference design; one on the HV side and two on the output side. The HV side loop starts from the bulk capacitor (C13) positive terminal, primary transformer winding (pin 1 and pin 3 of TR1), CoolSET™, CS resistors and back to the C13 negative terminal. The first output side loop (+12 V output) starts at the transformer winding (pin 14 of TR1), output diode D21, output capacitor C22 and back to pin 7 of TR1. The second output side loop (+18 V output) starts at the transformer winding (pin 6 of TR1), output diode D12, output capacitor C113 and back to pin 5 of T1.

Circuit description

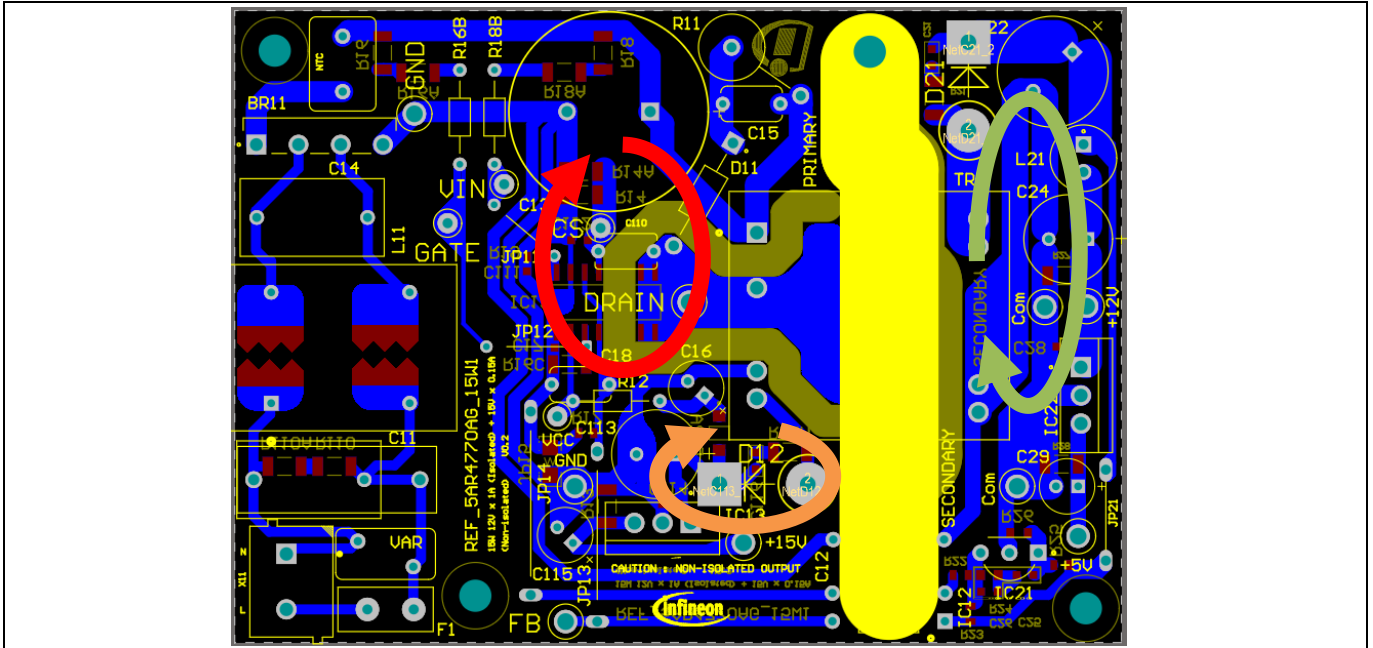

Figure 5 PCB layout tips

- Star-ground connection should be used to reduce High Frequency (HF) noise coupling that can affect the functional operation. The ground of the small-signal components, e.g. R16C, R17, R19, C17, C18 and C111, should connect directly to the IC ground (pin 12 of IC11).
- Separating the HV components and LV components, e.g. clamper circuit D11, C15 and R11, at the top part of the PCB and the other LV components at the lower part of the PCB can reduce the spark-over chance of the high energy surge during a lightning surge test.
- Make the PCB copper pour on the DRAIN pin of the MOSFET cover as wide an area as possible to act as a heatsink.

5.7 EMI reduction tips

EMI compliance is always a challenge for the power supply designer. There are several critical points to consider in order to achieve a satisfactory EMI performance.

- A proper transformer design can significantly reduce EMI. Low leakage inductance can incur a low switching spike and HF noise. Interlaced winding technique is the most common practice to reduce leakage inductance. Winding shield, core shield and whole transformer shield are also some of the techniques used to reduce EMI.
- Input CMC and X-capacitor greatly reduce EMI, but this is costly and impractical especially for low-power applications.
- Short-switching power-loop design in the PCB (as described in section 5.6) can reduce radiated EMI due to the antenna effect.
- An output diode snubber circuit can reduce HF noise.
- Ferrite beads can reduce HF noise, especially on critical nodes such as the DRAIN pin, clamper diode and output diode terminals. There is no ferrite bead used in this design, as this can reduce the efficiency due to additional losses especially on high-current terminals.

PCB layout

6 PCB layout

6.1 Top side

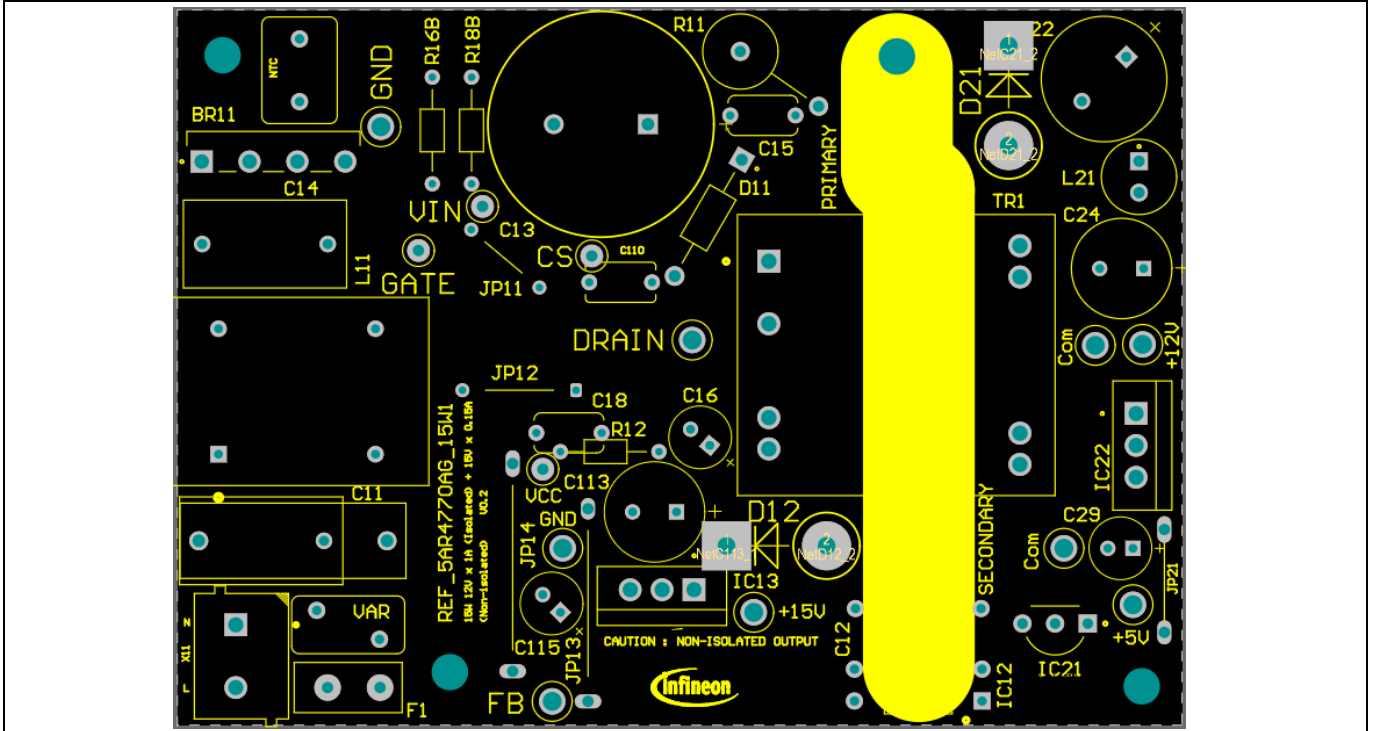

Figure 6 Top side component legend

6.2 Bottom side

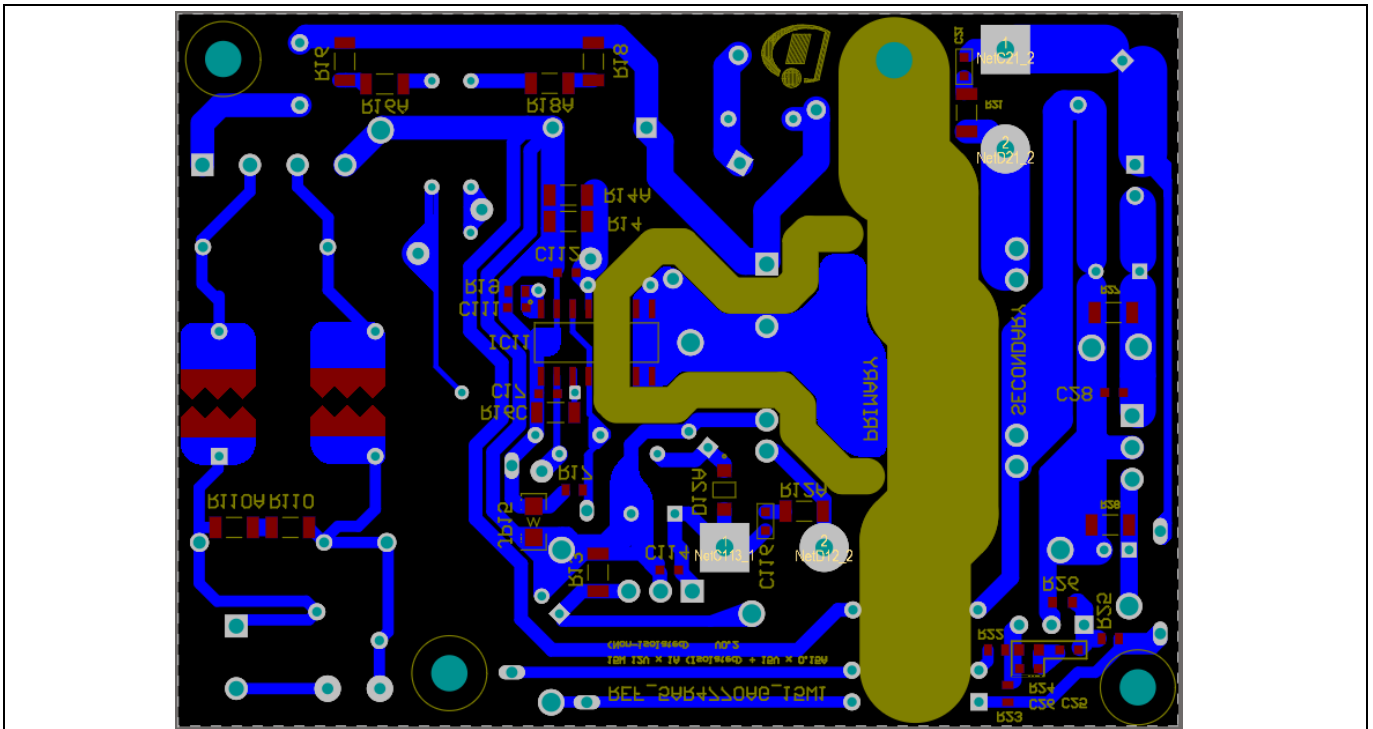

Figure 7 Bottom side copper and component legend

15 W auxiliary power supply for invertized air-conditioner using ICE5AR4770AG



BOM

7 BOM

Table 4 BOM (V 0.1)

No.	Designator	Description	Part number	Manufacturer	Quantity
1	+12 V, +15 V, DRAIN, FB	Connector	5010		4
2	C11	310 V AC, 100 nF	890334025017CS	Würth Elektronik	1
3	C12	1 nF	DE1E3RA102MA4BQ01F	Murata	1
4	C13	33 µF, 450 V	860241481006	Würth Elektronik	1
5	C15	1 nF	RDE7U3A102J2M1H03A	Murata	1
6	C16	35 V DC, 22 µF	860010572003	Würth Elektronik	1
7	C18	50 V, 1 nF	RDE5C1H102J0K1H03B	Murata	1
8	C17, C114	50 V, 100 nF	885012206095	Würth Elektronik	2
9	C22	25 V DC, 820 µF	860040475010	Würth Elektronik	1
10	C24	25 V DC, 220 µF	860040474004	Würth Elektronik	1
11	C25	50 V, 330 nF	885012206121	Würth Elektronik	1
12	C26	50 V, 1 nF	885012206083	Würth Elektronik	1
13	C115	25 V DC, 10 µF	860010472002	Würth Elektronik	1
14	C111	50 V, 22 nF	885012206091	Würth Elektronik	1
15	C113	35 V DC, 220 µF	860010574011	Würth Elektronik	1
16	Com, GND	Connector	5011		3
17	CS, GATE, VIN	Connector	5002		3
18	D11	1N4006G	1N4006G		1
19	BR11	800 V, 1.2 A	UD2KB80-D3K	Shindengen	1
20	D12	200 V, 4 A	MUR420G		1
21	D21	100 V, 5 A	SB5H100-E3/54		1
22	D12A	200 V, 0.8 A	RS1DL		1
23	F1	300 V, 1.6 A	36911600000		1
24	IC11	CoolSET™	ICE5AR4770AG	Infineon Technologies AG	1
25	IC12	SFH617A-3X006	SFH617A-3X006		1
26	IC13	LM2937ET-15	LM2937ET-15		1
27	IC21	TL431BVLPG	TL431BVLPG		1
28	JP11, JP12, JP21, JP13, JP14, NTC	Jumper			6
29	JP15	0 R, 0805			1
30	L11	47 mH, 0.75 A	750342434	Würth Elektronik	1
31	L21	4.7 µH, 4.2 A	7447462047	Würth Elektronik	1
32	R11	820 k	PR02000208203JR500		1
33	R12	18 R	CFR-12JR-52-18R		1
34	R14, R14A	2 R	CRCW12062R00FKTA		2
35	R16, R16A	20 MEG	RC1206JR-0720ML		2
36	R16B	20 MEG	RN55D2005FB14		1
37	R16C	15 MEG	RC1206JR-0715ML		1
38	R17	750 k	CRCW0603750KFK		1
39	R18	5.9 MEG	CRCW12065M90FK		1
40	R18A	5.1 MEG	CRCW12065M10FK		1
41	R18B	5.1 MEG	299-5.1M-RC		1
42	R19	110 k	CRCW0603110KFK		1
43	R22	820 R	CRCW0603820RFK		1
44	R23	1.2 k	CRCW06031K20FK		1
45	R24	20 k	TNPW060320K0BY		1

15 W auxiliary power supply for invertized air-conditioner using ICE5AR4770AG



BOM

46	R25	38.3 k	CRCW060338K3FK		1
47	R26	10 k	RC0603FR-0710KL		1
48	R110, R110A	4.7 MEG	CRCW12064M70FK		2
49	TR1	550 μ H (64:11:8) EE20/10/6 TP4A (TDG)	750344251 (R02)	Würth Elektronik	1
50	VAR	320 V, 0.25 W	B72207S2321K101	TDK Corporation	1
51	VCC	Connector	5000		1
52	X11	Connector	691 102 710 002	Würth Elektronik	1
53	PCB	80 mm x 57 mm (L x W) single-layer, 2 oz, FR-4			1

Transformer specification

8 Transformer specification

Refer to Appendix A for transformer design and Appendix B for WE transformer specification.

Core name and material: EE20/10/6, TP4A (TDG)

Würth Elektronik bobbin: 070-5643 (14-pin, THT, horizontal version)

Primary inductance: $L_p = 550 \mu\text{H}$ (± 10 percent), measured between pin 1 and pin 3

Manufacturer and part number: Würth Elektronik Midcom (750344251) Rev.02

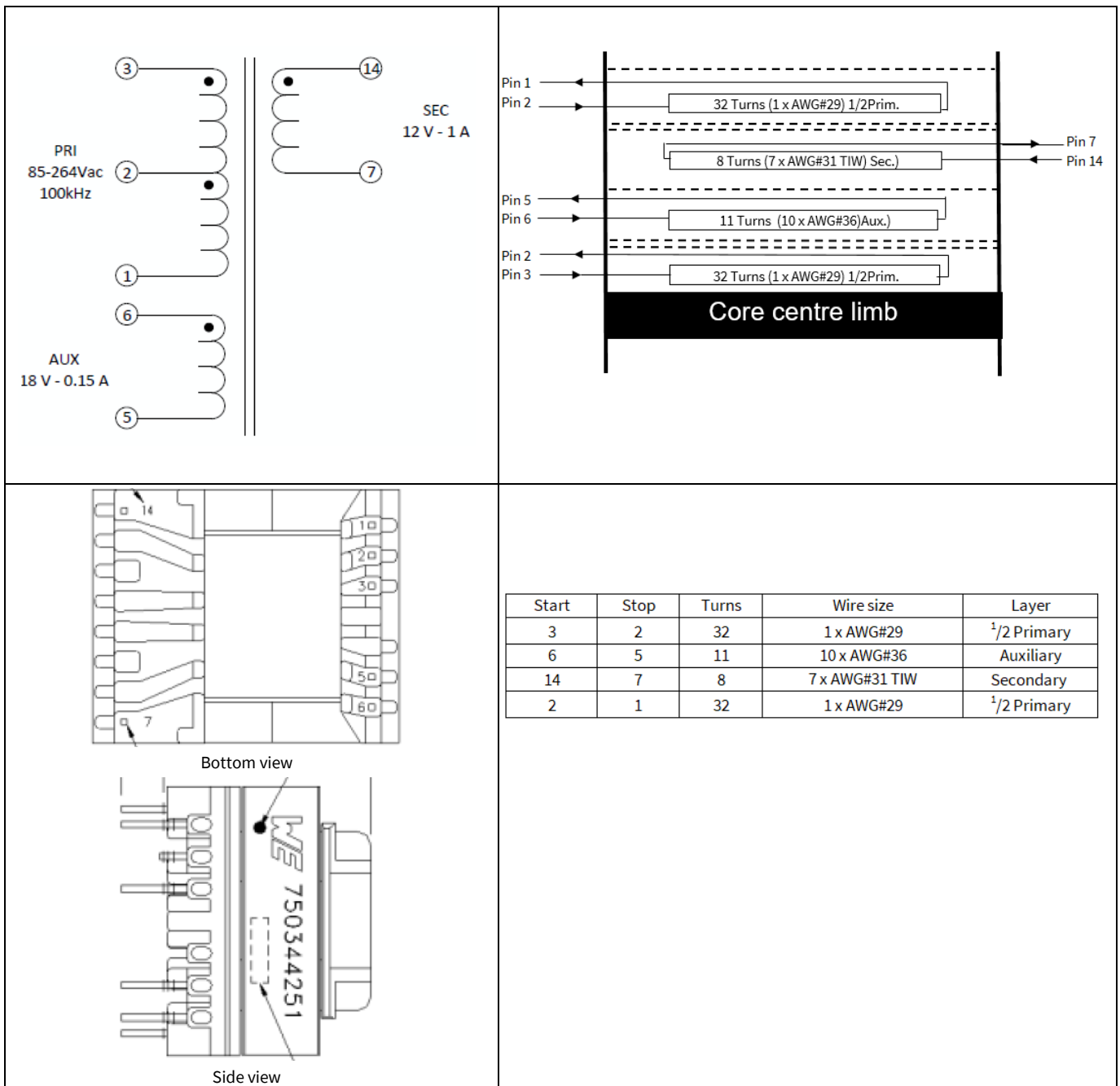

Figure 8 Transformer structure

9 Measurement data and graphs

Table 5 Electrical measurements

Input (V AC/Hz)	P _{IN} (W)	+12 V _{OUT} (V)	+12 I _{OUT} (A)	+15 V _{OUT} (V)	+15 I _{OUT} (A)	P _{OUT} (W)	Efficiency (%)	Average efficiency (%)	OLP P _{IN} (W)	OLP +12 I _{OUT} at 15 V/0.15 A (A)
85 V AC/ 60 Hz	0.07	11.99	0.00	14.93	0.0000	/	/	/	23.50	1.36
	0.85	11.99	0.04	14.93	0.0100	0.63	73.99	/		
	4.32	11.98	0.25	14.93	0.0370	3.55	82.12	81.90		
	8.63	11.98	0.50	14.93	0.0757	7.12	82.51			
	13.01	11.97	0.75	14.93	0.1130	10.67	82.00			
	17.55	11.97	1.00	14.92	0.1503	14.21	80.98			
115 V AC/ 60 Hz	0.07	11.96	0.00	14.93	0.0000	/	/	/	22.90	1.39
	0.85	11.99	0.04	14.93	0.0100	0.63	73.99	/		
	4.27	11.98	0.25	14.93	0.0370	3.55	83.08	83.46		
	8.50	11.98	0.50	14.93	0.0757	7.12	83.77			
	12.73	11.97	0.75	14.93	0.1130	10.67	83.80			
	17.08	11.97	1.00	14.92	0.1503	14.21	83.21			
220 V AC/ 50 Hz	0.08	11.99	0.00	14.93	0.0000	/	/	/	22.80	1.41
	0.86	11.99	0.04	14.93	0.0100	0.63	73.13	/		
	4.29	11.98	0.25	14.93	0.0370	3.55	82.69	84.02		
	8.48	11.98	0.50	14.93	0.0757	7.12	83.96			
	12.60	11.97	0.75	14.93	0.1130	10.67	84.66			
	16.76	11.97	1.00	14.92	0.1500	14.21	84.77			
264 V AC/ 50 Hz	0.09	11.96	0.00	14.93	0.0000	/	/	/	23.10	1.45
	0.87	11.99	0.04	14.93	0.0100	0.63	72.29	/		
	4.32	11.98	0.25	14.93	0.0370	3.55	82.12	83.68		
	8.53	11.98	0.50	14.93	0.0757	7.12	83.47			
	12.63	11.97	0.75	14.93	0.1130	10.67	84.47			
	16.78	11.97	1.00	14.93	0.1500	14.21	84.67			

Minimum load condition: 12 V/40 mA, 15 V/10 mA

25 percent load condition: 12 V/0.25 A, 15 V/0.038 A

50 percent load condition: 12 V/0.50 A, 15 V/0.075 A

75 percent load condition: 12 V/0.75 A, 15 V/0.113 A

100 percent load condition: 12 V/1.00 A, 15 V/0.15 A

9.1 Efficiency curve

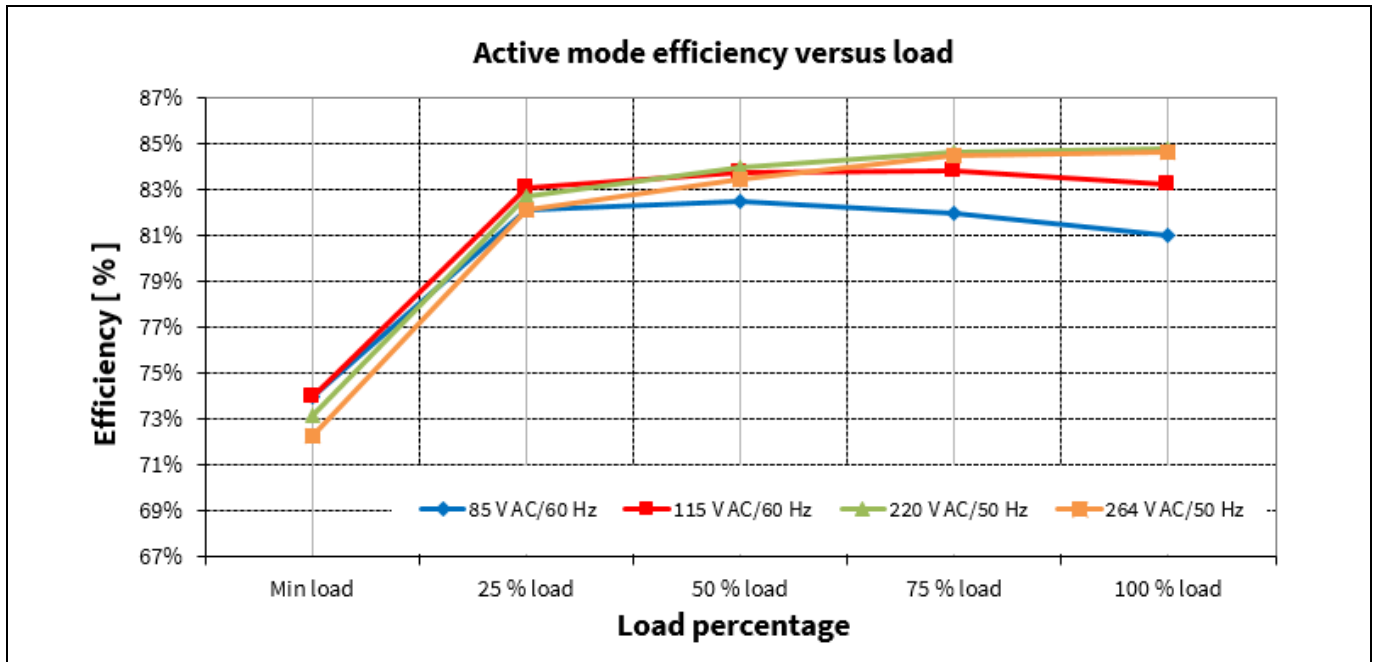

Figure 9 Efficiency vs output load

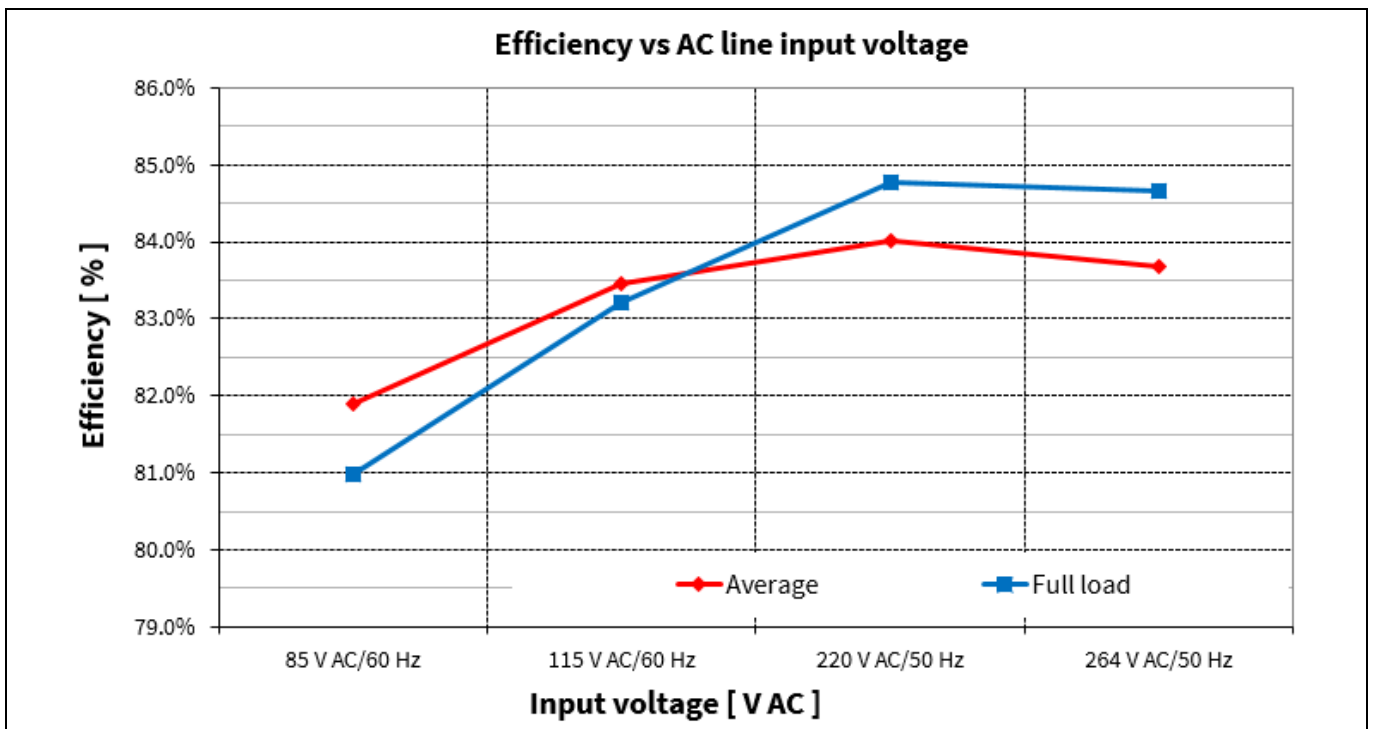

Figure 10 Efficiency vs AC-line input voltage

9.2 Standby power

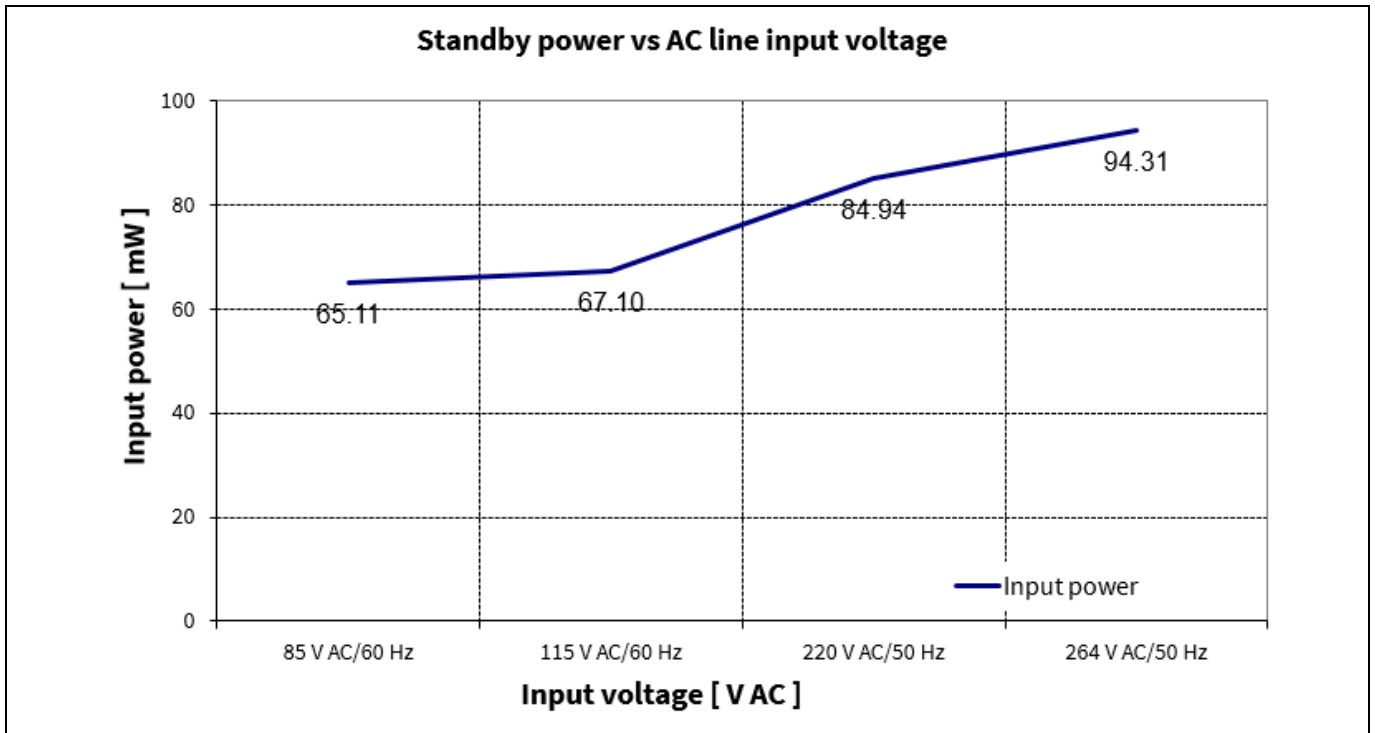

Figure 11 Standby power at no-load vs AC-line input voltage (measured by Yokogawa WT210 power meter – integration mode)

9.3 Line and load regulation

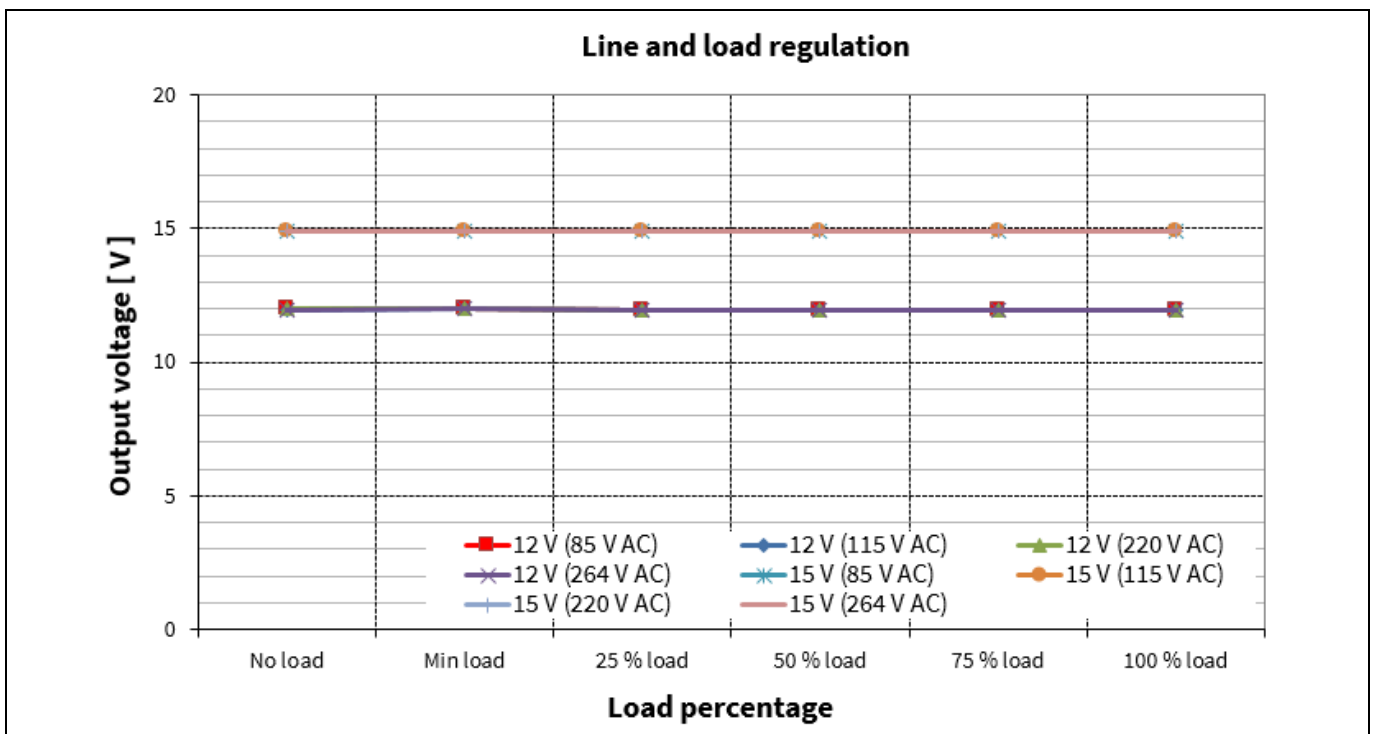

Figure 12 Output regulation vs load at different AC-line input voltages

9.4 Maximum input power

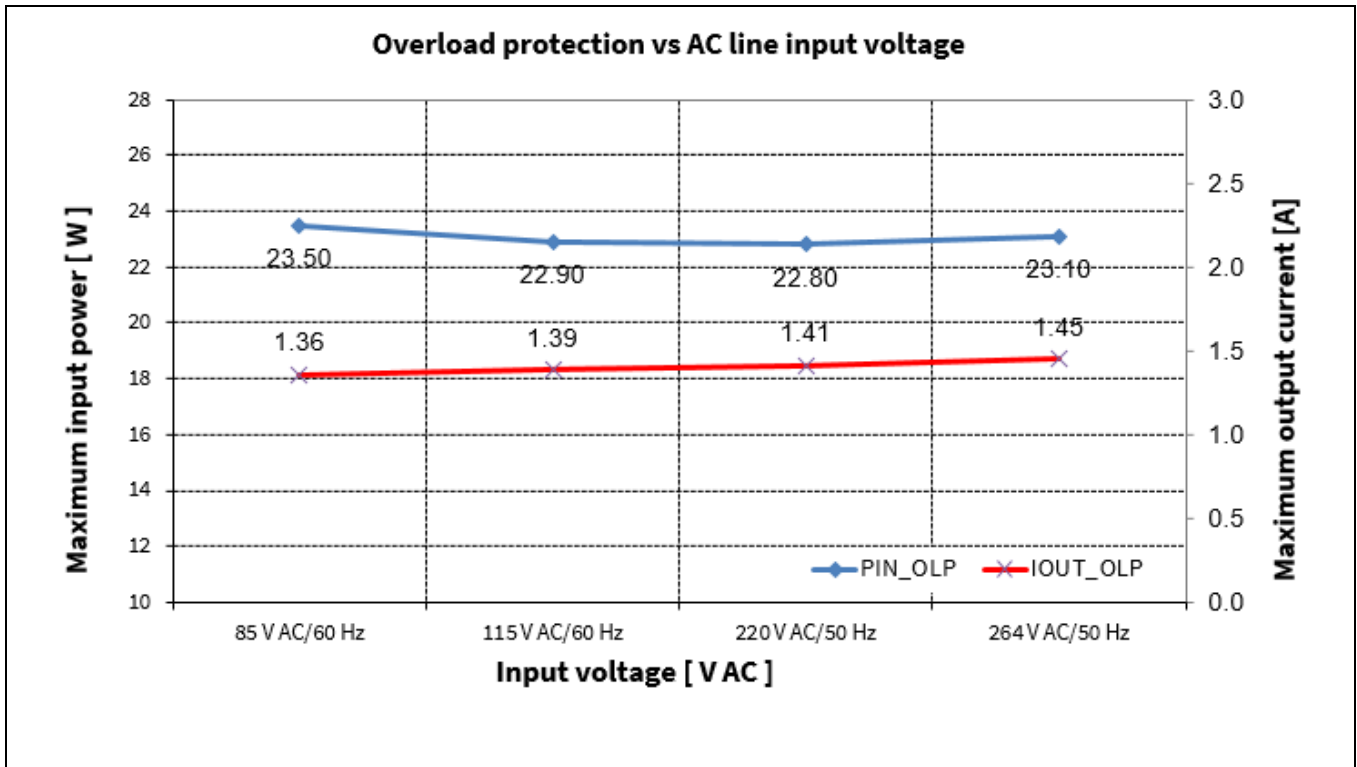

Figure 13 Maximum input power and output current (before over-load protection) vs AC-line input voltage at 15 V/0.15 A load

9.5 Frequency reduction

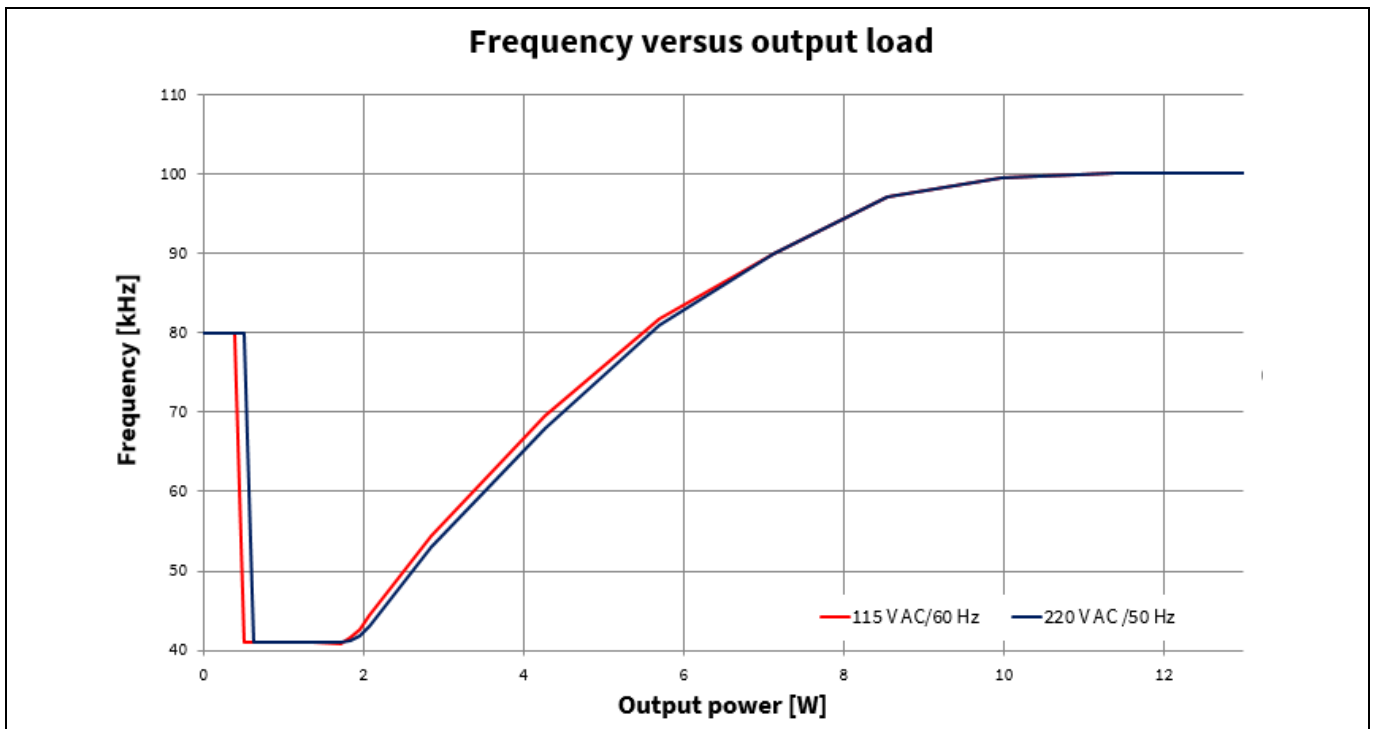

Figure 14 Frequency reduction curve vs output load

Measurement data and graphs

9.6 ESD immunity (EN 61000-4-2)

This system was subjected to a ± 8 kV ESD test according to EN 61000-4-2 for both contact and air discharge. A test failure was defined as non-recoverable.

- Air discharge: pass ± 8 kV; contact discharge: pass ± 8 kV.

Table 6 System ESD test result

Description	ESD test	Level	Number of strikes		Test result
			+12 V _{OUT}	Com	
115 V AC, 14.25 W	Contact	+8 kV	10	10	Pass
		-8 kV	10	10	Pass
	Air	+8 kV	10	10	Pass
		-8 kV	10	10	Pass
220 V AC, 14.25 W	Contact	+8 kV	10	10	Pass
		-8 kV	10	10	Pass
	Air	+8 kV	10	10	Pass
		-8 kV	10	10	Pass

9.7 Surge immunity (EN 61000-4-5)

The reference board was subjected to a surge immunity test (± 2 kV DM and ± 4 kV CM) according to EN 61000-4-5. It is tested at full load (14.25 W) using resistive load with LOVP disabled (add 2.4 V Zener diode at VIN pin to GND pin). A test failure was defined as a non-recoverable.

- DM: pass ± 2 kV¹; CM: pass ± 4 kV¹.

Table 7 System surge immunity test result

Description	Test	Level		Number of strikes				Test result
				0°	90°	180°	270°	
115 V AC, 14.25 W	DM	+2 kV	L → N	3	3	3	3	Pass ¹
		-2 kV	L → N	3	3	3	3	Pass ¹
	CM	+4 kV	L → G	3	3	3	3	Pass ¹
		+4 kV	N → G	3	3	3	3	Pass ¹
		-4 kV	L → G	3	3	3	3	Pass ¹
		-4 kV	N → G	3	3	3	3	Pass ¹
220 V AC, 14.25 W	DM	+2 kV	L → N	3	3	3	3	Pass ¹
		-2 kV	L → N	3	3	3	3	Pass ¹
	CM	+4 kV	L → G	3	3	3	3	Pass ¹
		+4 kV	N → G	3	3	3	3	Pass ¹
		-4 kV	L → G	3	3	3	3	Pass ¹
		-4 kV	N → G	3	3	3	3	Pass ¹

¹ 1. Disable line OVP by clamping VIN pin voltage to less than 2.75 V (add 2.4 V Zener diode at VIN pin to GND pin).

Measurement data and graphs

9.8 Conducted emissions (EN 55022 class B)

The conducted EMI was measured by Schaffner (SMR4503) and followed the test standard of EN 55022 (CISPR 22) class B. The reference board is tested at full load (14.25 W) using resistive load at input voltage of 115 V AC and 220 V AC.

- 115 V AC: pass with greater than 8 dB margin for quasi-peak measurement
- 220 V AC: pass with greater than 10 dB margin for quasi-peak measurement

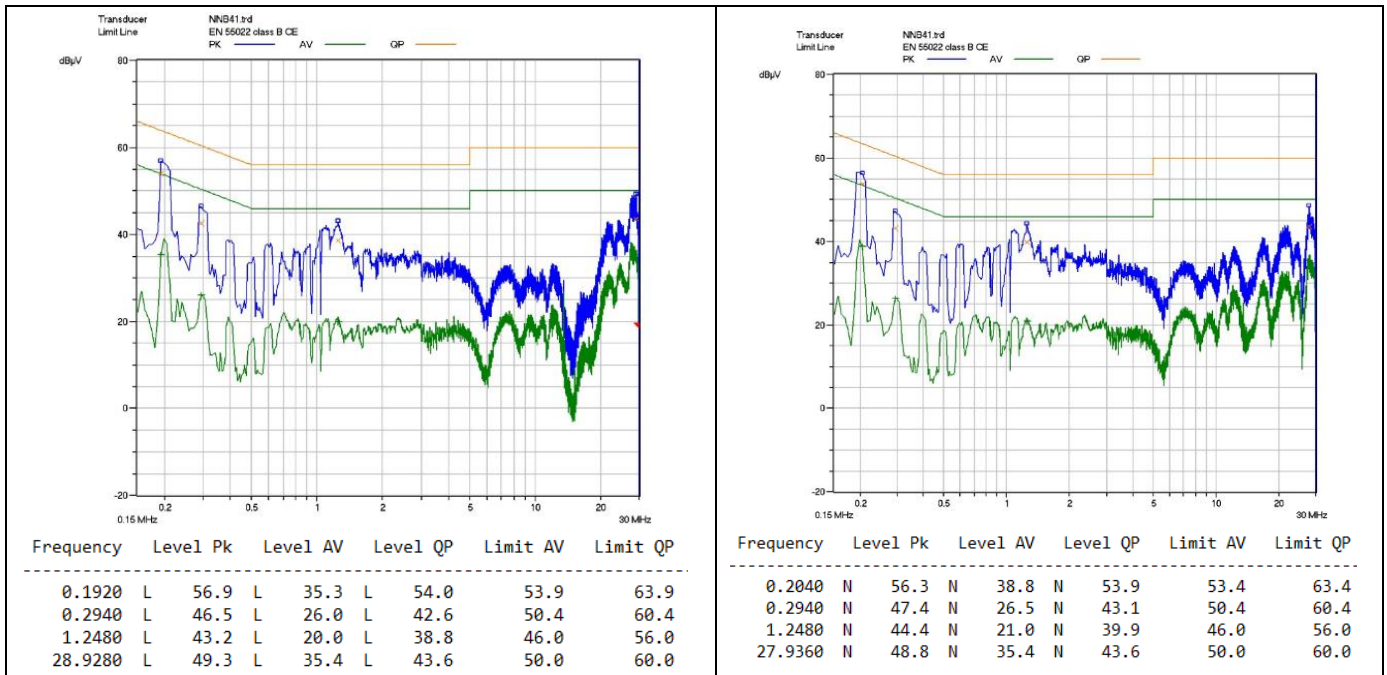

Figure 15 Conducted emissions at 115 V AC and full load on line (left) and neutral (right)

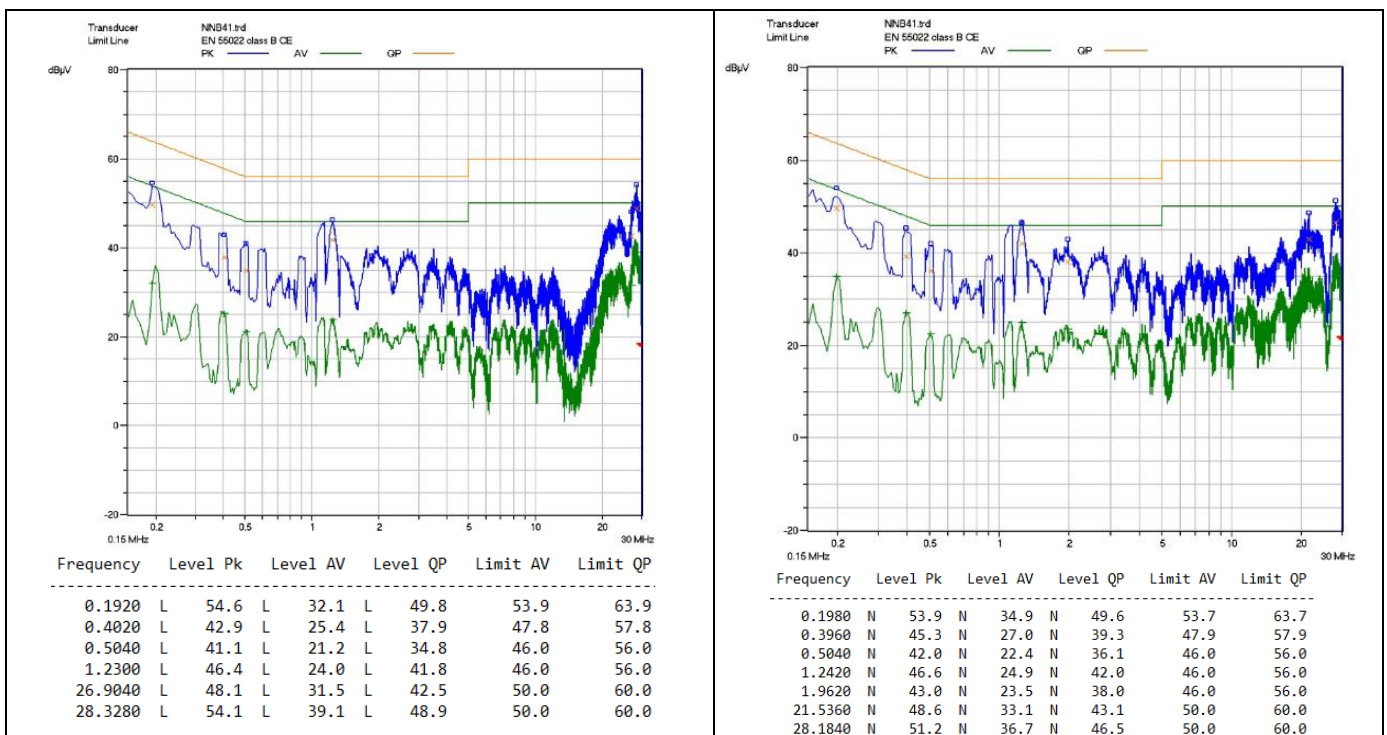

Figure 16 Conducted emissions at 220 V AC and full load on line (left) and neutral (right)

15 W auxiliary power supply for invertized air-conditioner using ICE5AR4770AG

Measurement data and graphs

9.9 Thermal measurement

Thermal measurement was done using an infrared thermography camera (FLIR-T62101) at an ambient temperature of 25°C taken after one hour running at full load. The temperature of the components was taken in an open-frame set-up.

Table 8 Thermal measurement of components (open-frame)

No.	Component	Temperature at 85 V AC (°C)	Temperature at 264 V AC (°C)
1	D21 (+12 V diode)	63.7	64.1
2	TR1 (transformer)	55.8	58.3
3	IC13 (15 V regulator)	53.2	51.5
4	IC11 (ICE5AR4770AG)	74.4	57.1

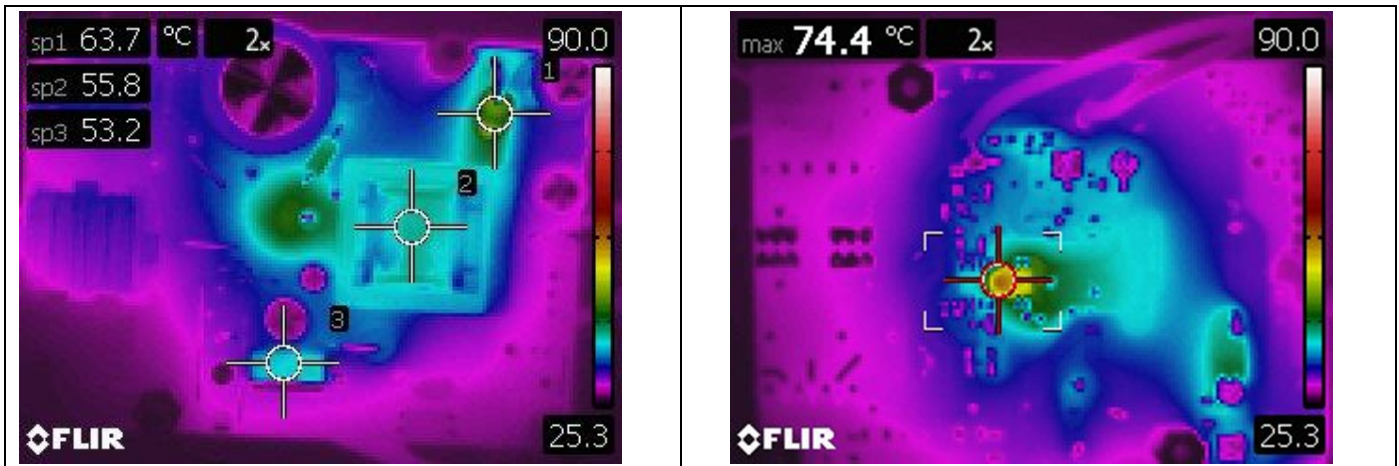

Figure 17 Top layer (left) and bottom layer (right) thermal image at 85 V AC input voltage

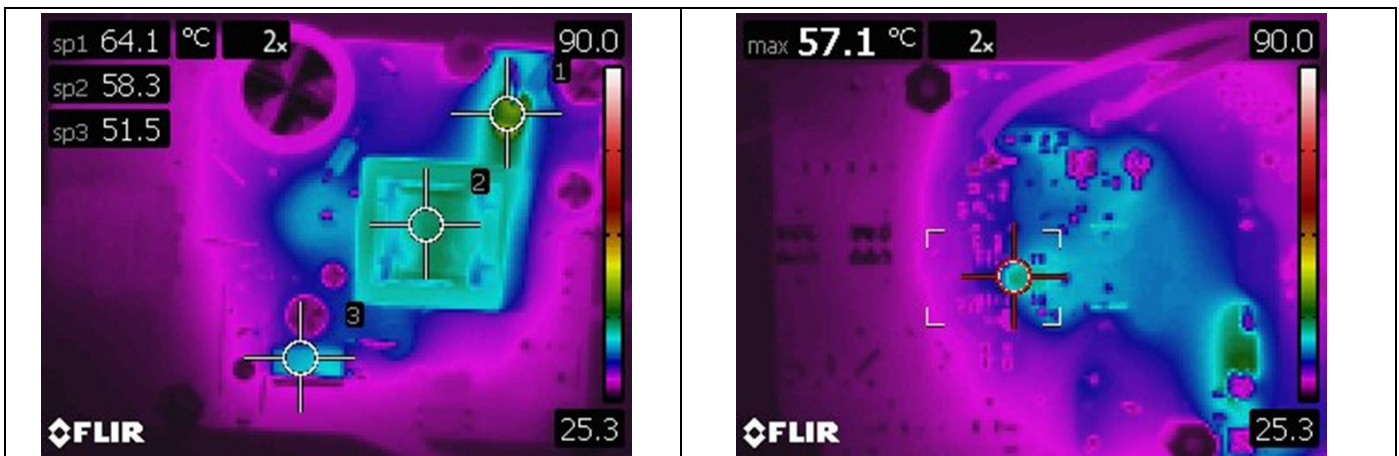

Figure 18 Top layer (left) and bottom layer (right) thermal image at 264 V AC input voltage

Measurement data and graphs

9.10 +18 V rail regulation (LDO input)

As the +15 V output via a LDO is derived from the +18 V rail from the transformer which is also shared by the CoolSET™ V_{CC} , there are several design goals to achieve during normal operating conditions:

- Avoid V_{CC} UVLO (10 V typ.)
- Avoid V_{CC} OVP (25.5 V typ.)
- Ensure that the +18 V rail does not exceed the specification of the LDO (V_{in_min} : 15.5 V and V_{in_max} : 26 V)

From the chart and table below, the +18 V rail is operating between 16.88 V and 21.25 V under different load combinations and line conditions, which is well within the design objectives outlined above.

Table 9 +18 V rail line and load regulation

	12 V/0 A, 15 V/0 A (V)	12 V/40 mA, 15 V/10 mA (V)	12 V/40 mA, 15 V/0.15 A (V)	12 V/1.0 A, 15 V/10 mA (V)	12 V/1.0 A, 15 V/0.15 A (V)
85 V AC/60 Hz	16.00	16.70	15.85	22.90	16.89
115 V AC/60 Hz	16.07	16.70	15.85	22.90	16.93
220 V AC/50 Hz	15.99	16.63	15.80	23.20	17.05
264 V AC/50 Hz	15.98	16.63	15.80	23.16	17.07

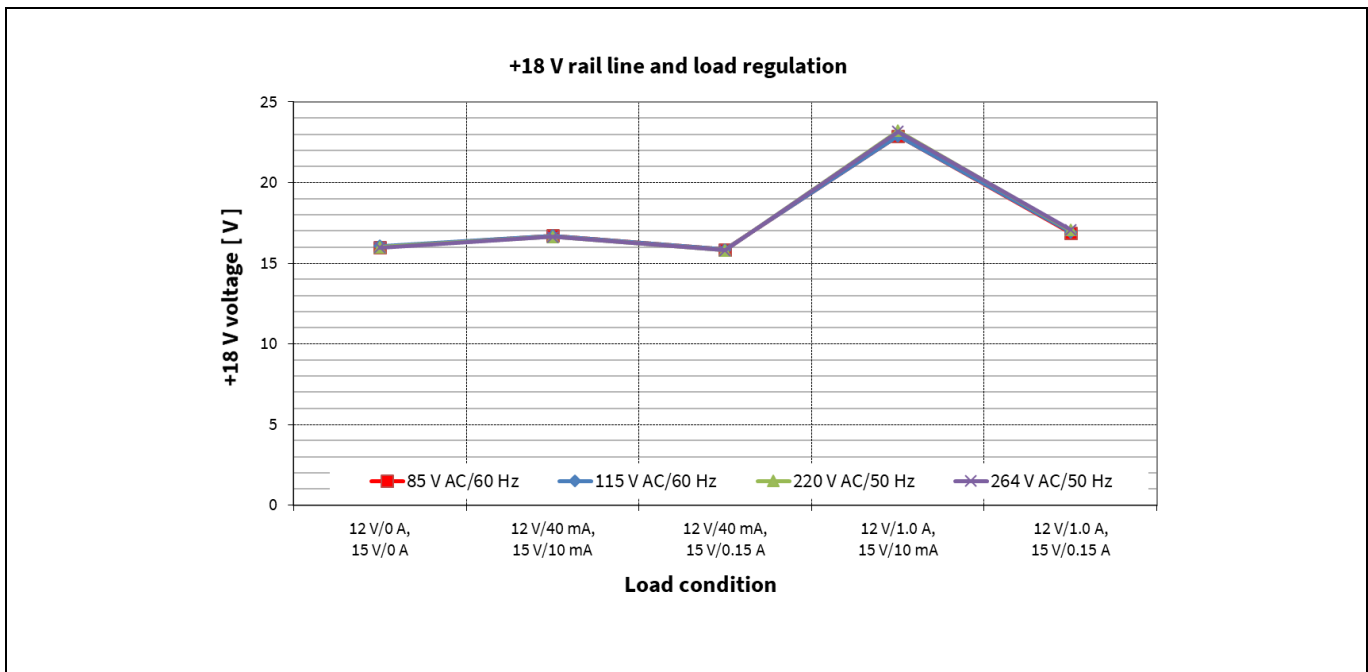

Figure 19 +18 V rail regulation

15 W auxiliary power supply for invertized air-conditioner using ICE5AR4770AG

Waveforms and oscilloscope plots

10 Waveforms and oscilloscope plots

All waveforms and scope plots were recorded with a Teledyne LeCroy HDO4034 oscilloscope.

10.1 Start-up at full load

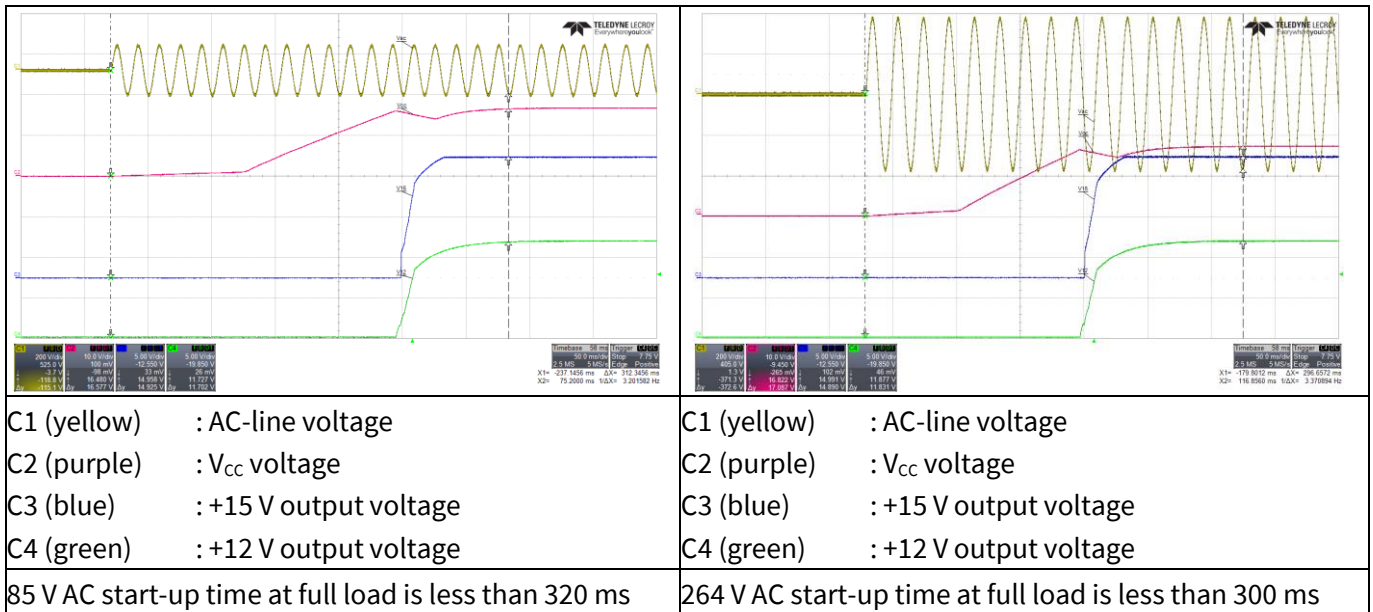

Figure 20 Start-up

10.2 Soft-start at full load

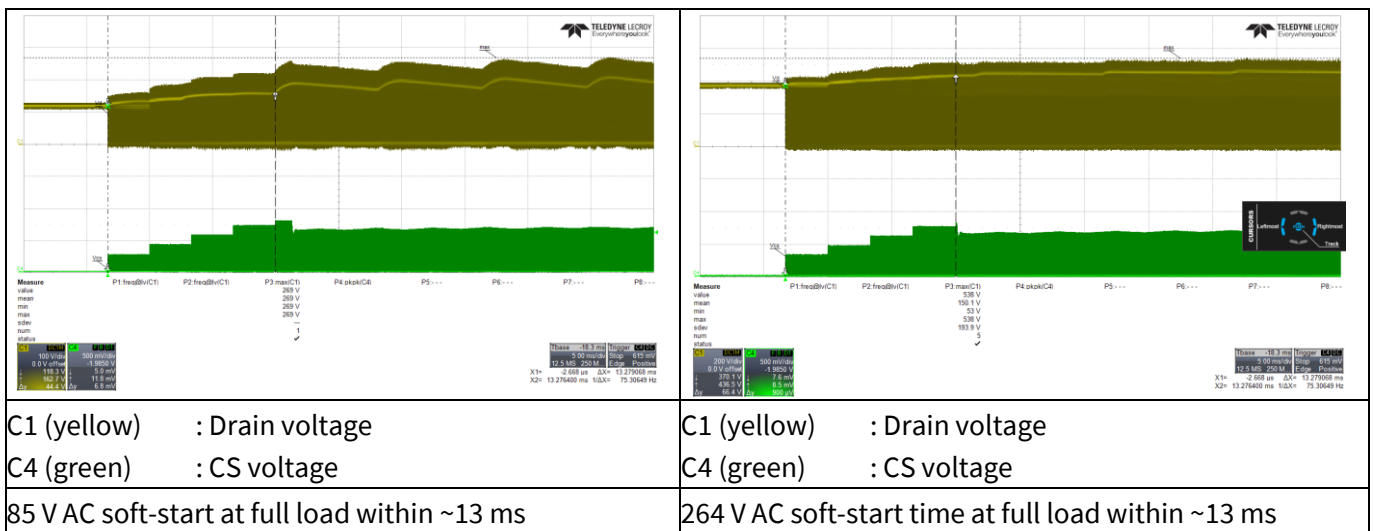

Figure 21 Soft-start

15 W auxiliary power supply for invertized air-conditioner using ICE5AR4770AG

Waveforms and oscilloscope plots

10.3 Drain and CS voltage at full load

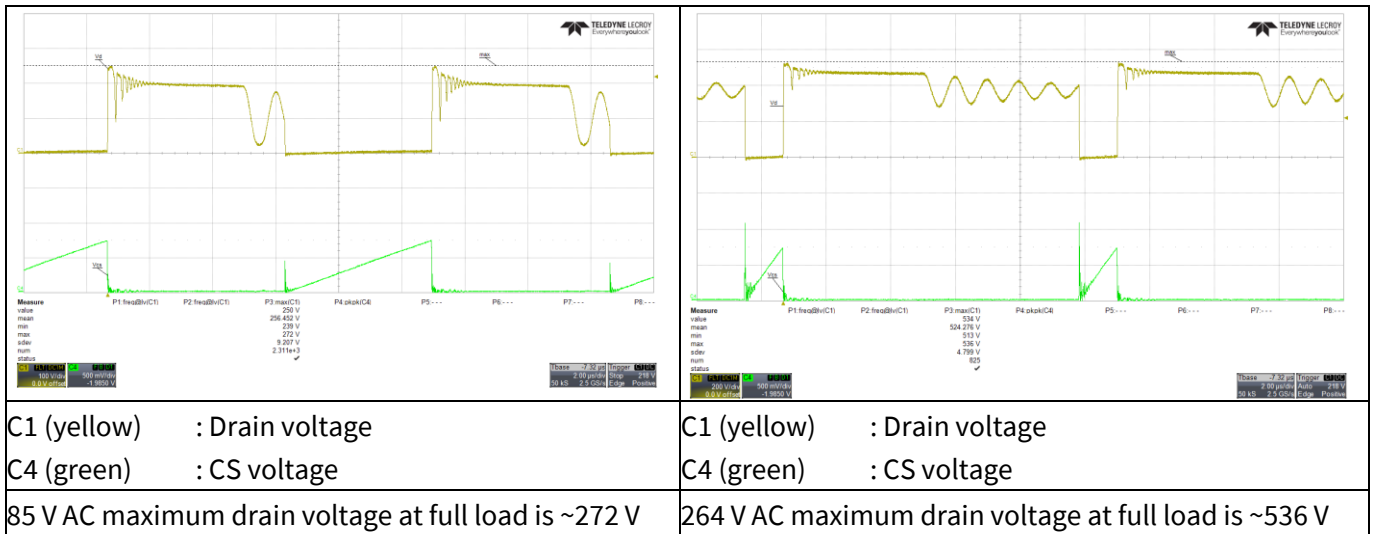

Figure 22 Drain and CS voltage

10.4 Frequency jittering and modulated gate drive at full load

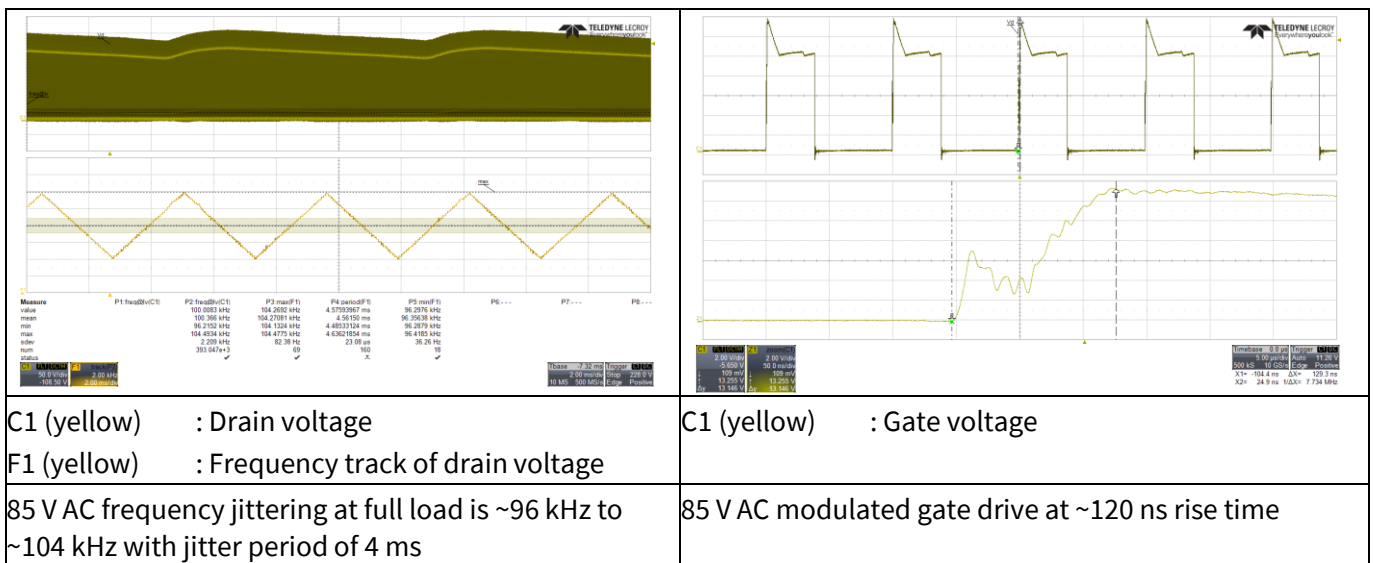

Figure 23 Frequency jittering and modulated gate drive

15 W auxiliary power supply for invertized air-conditioner using ICE5AR4770AG

Waveforms and oscilloscope plots

10.5 Load-transient response (dynamic load from minimum to full load)

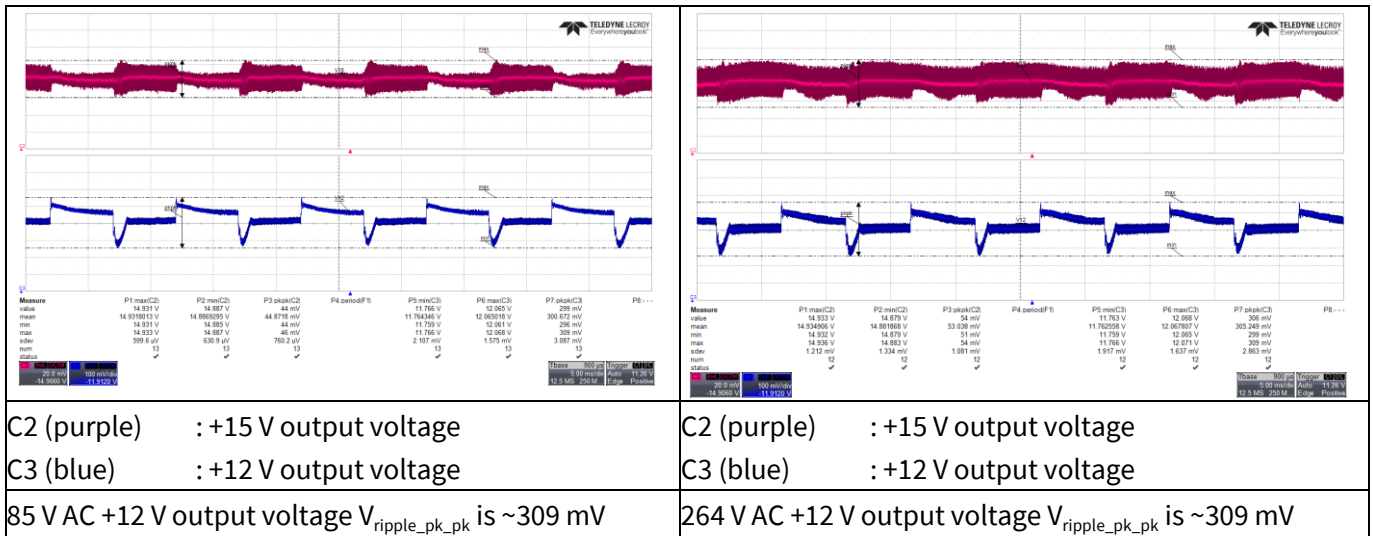

Figure 24 Load-transient response with +12 V output load change from minimum (40 mA) to full load (1 A) at 0.4 A/μs slew rate, 100 Hz. +15 V output load is fixed at 0.15 A. Probe terminals are decoupled with 1 μF electrolytic and 0.1 μF ceramic capacitors. Oscilloscope is bandwidth filter limited to 20 MHz.

10.6 Output ripple voltage at full load

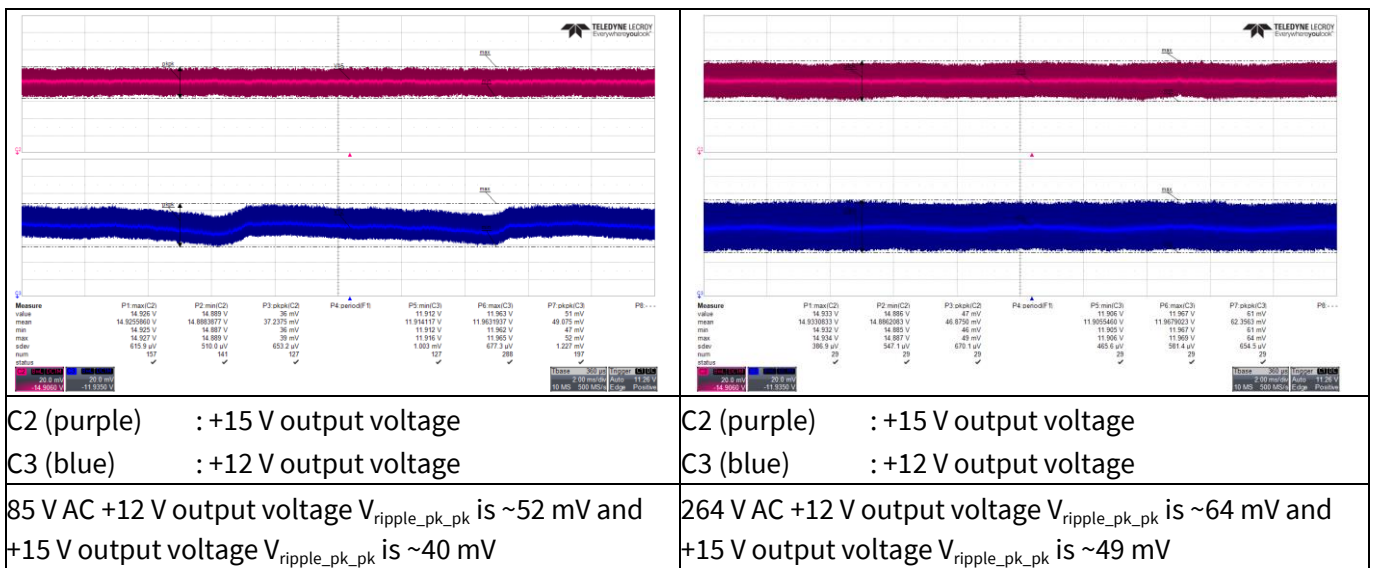

Figure 25 Output ripple voltage at full load. Probe terminals are decoupled with 1 μF electrolytic and 0.1 μF ceramic capacitors. Oscilloscope is bandwidth filter limited to 20 MHz.

15 W auxiliary power supply for invertized air-conditioner using ICE5AR4770AG

Waveforms and oscilloscope plots

10.7 Output ripple voltage at ABM (minimum load)

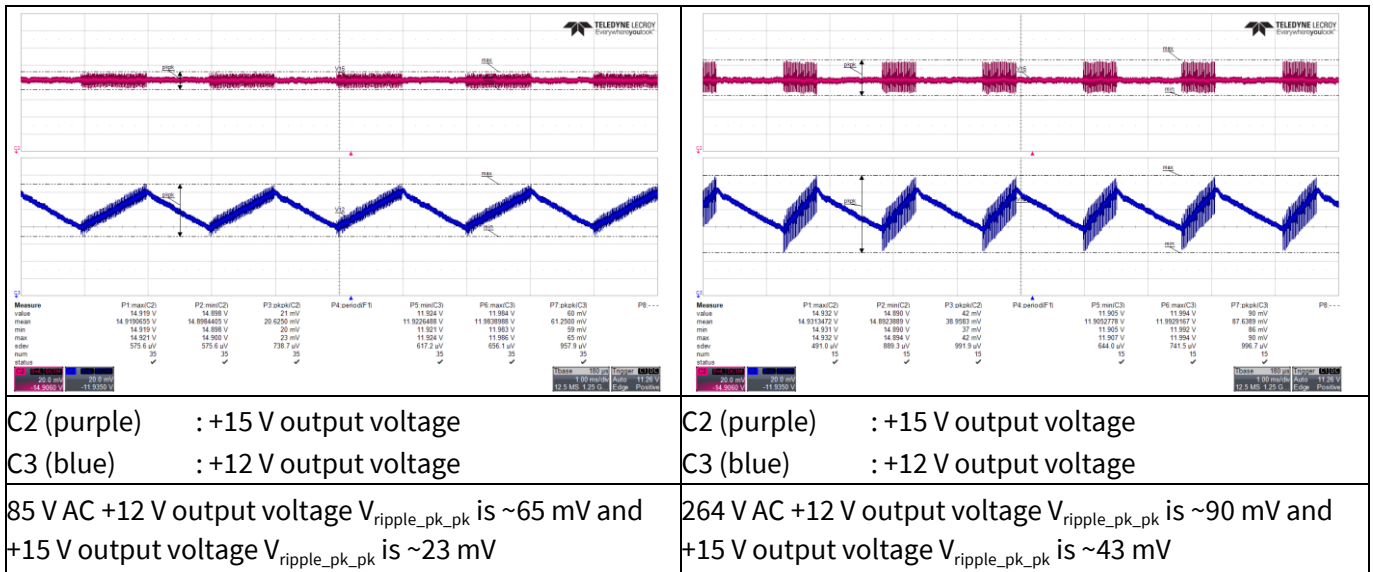

Figure 26 Output ripple voltage at minimum load. Probe terminals are decoupled with 1 μ F electrolytic and 0.1 μ F ceramic capacitors. Oscilloscope is bandwidth filter limited to 20 MHz.

10.8 Entering ABM

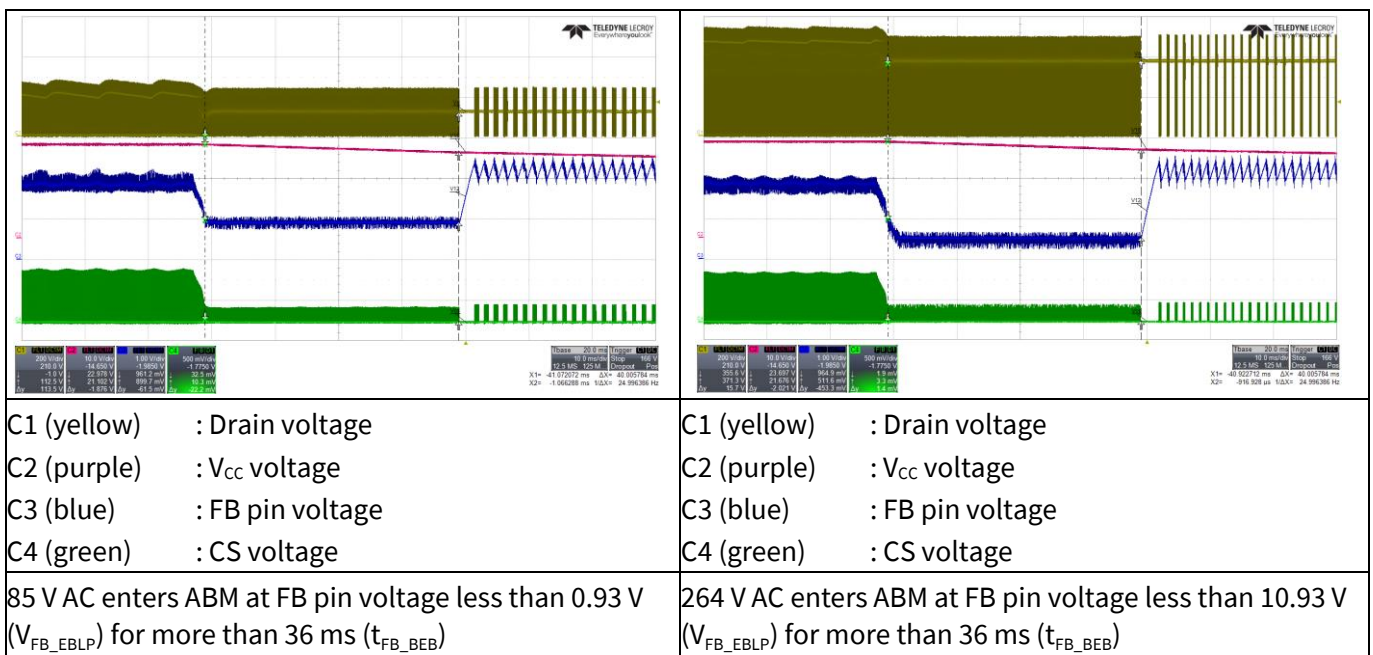

Figure 27 Entering ABM. +12 V output load from 1 A to 40 mA load. +15 V output has 10 mA fixed load.

15 W auxiliary power supply for invertized air-conditioner using ICE5AR4770AG

Waveforms and oscilloscope plots

10.9 During ABM

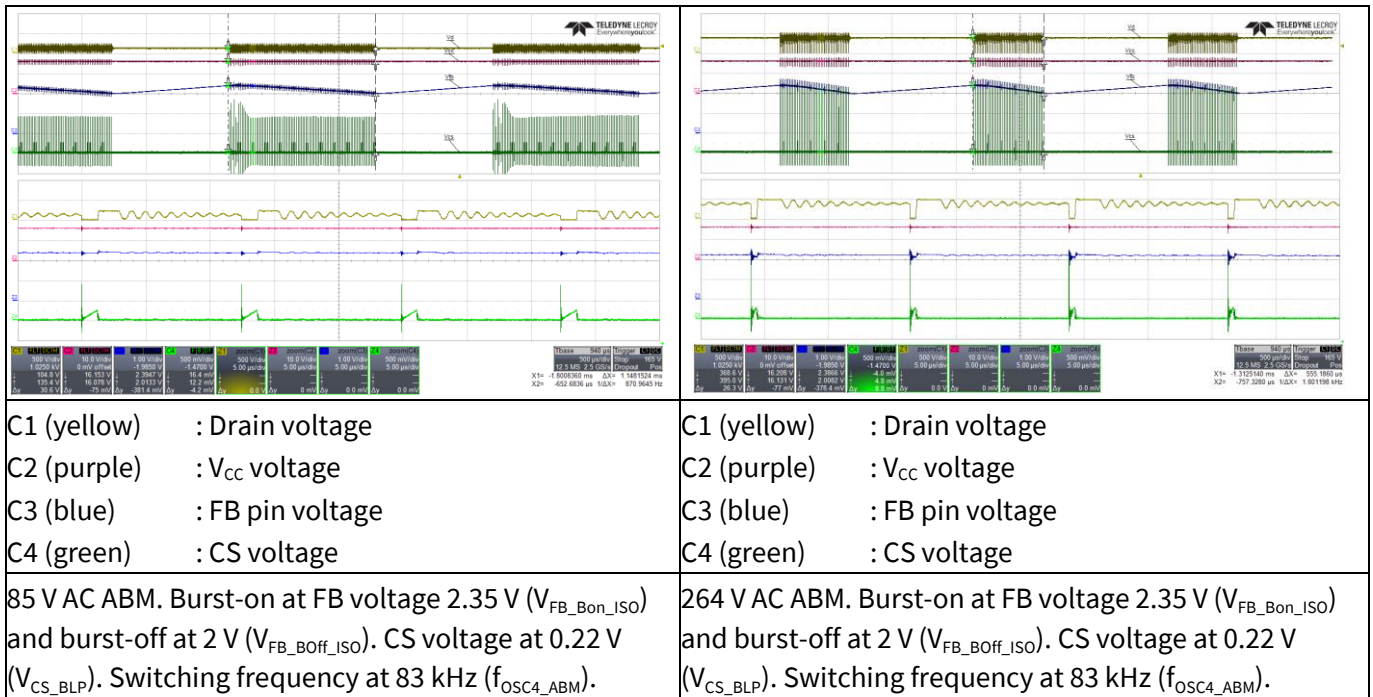

Figure 28 During ABM. Output at minimum load.

10.10 Leaving ABM

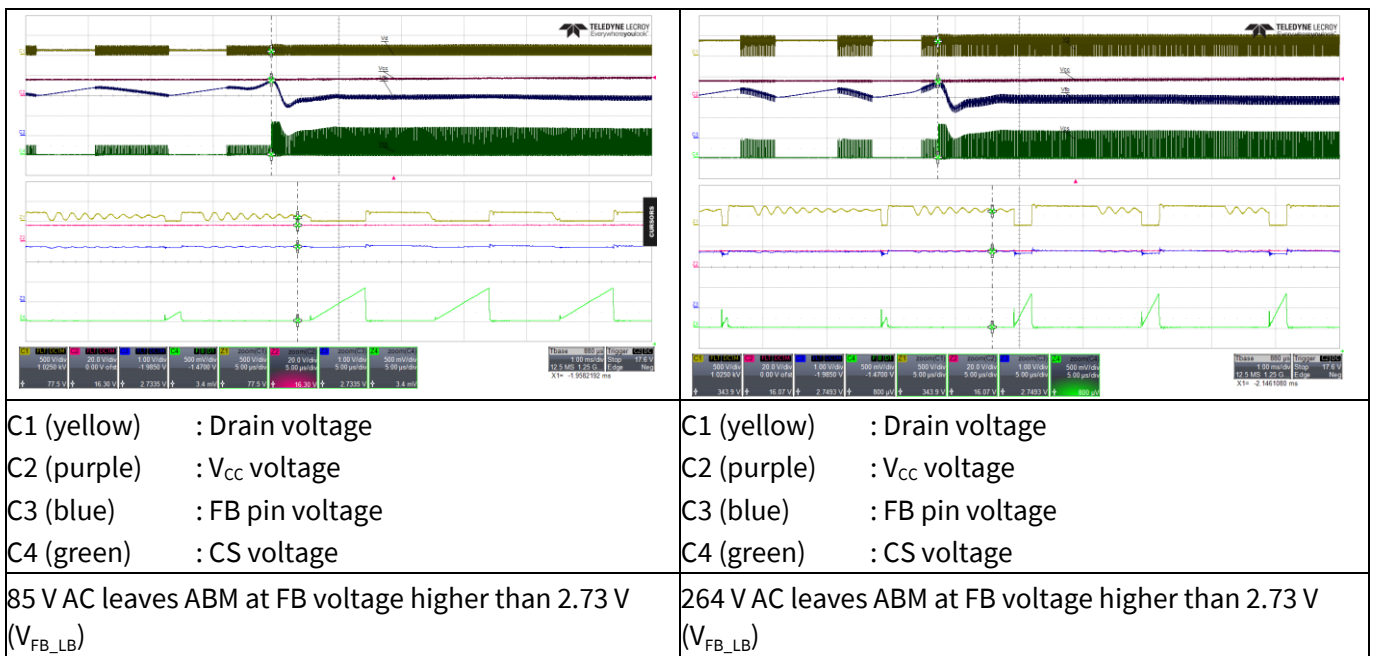

Figure 29 Leaving ABM. +12 V output load from 40 mA to 1 A load. +15 V output has 10 mA fixed load.

15 W auxiliary power supply for inverted air-conditioner using ICE5AR4770AG

Waveforms and oscilloscope plots

10.11 V_{CC} OV/UV protection

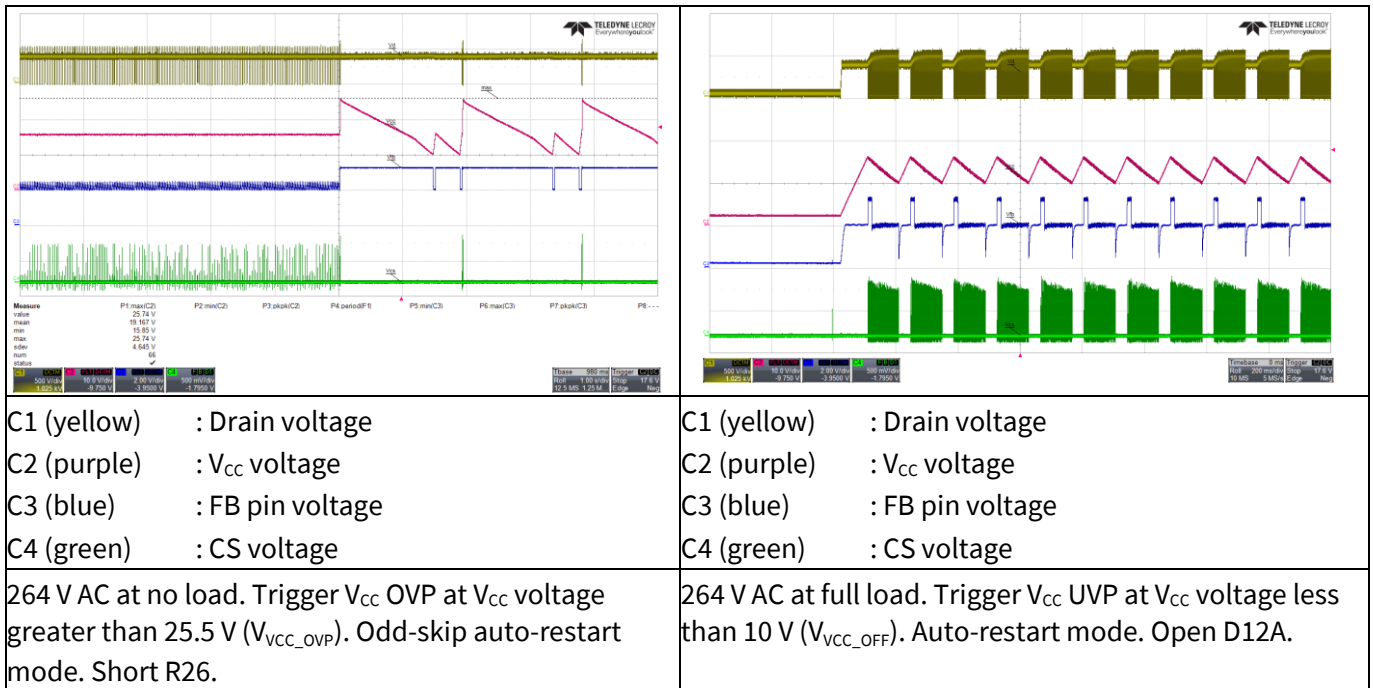

Figure 30 V_{CC} OV/UV protection

10.12 Over-load protection

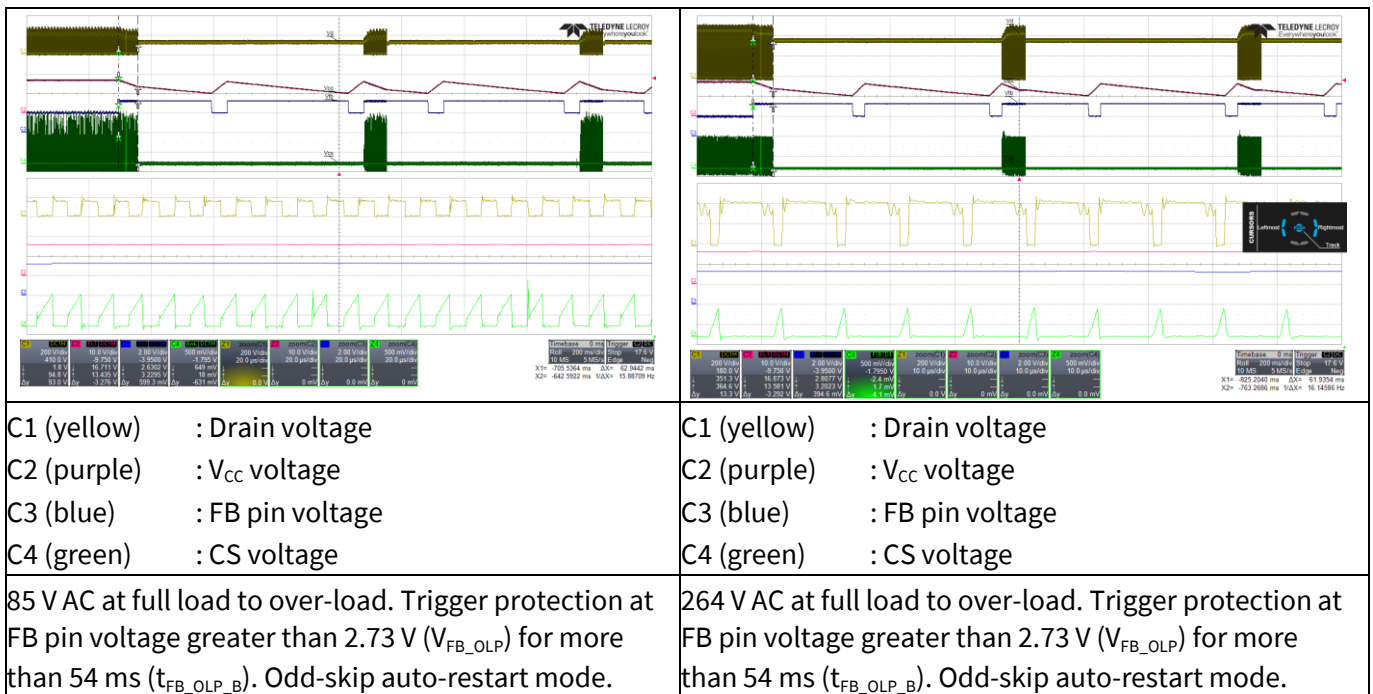

Figure 31 Over-load protection. Load increased at +12 V output from 1 A to 2 A load to trigger protection. +15 V output has 0.15 A fixed load.

15 W auxiliary power supply for invertized air-conditioner using ICE5AR4770AG



Waveforms and oscilloscope plots

10.13 Brown-in and LOVP

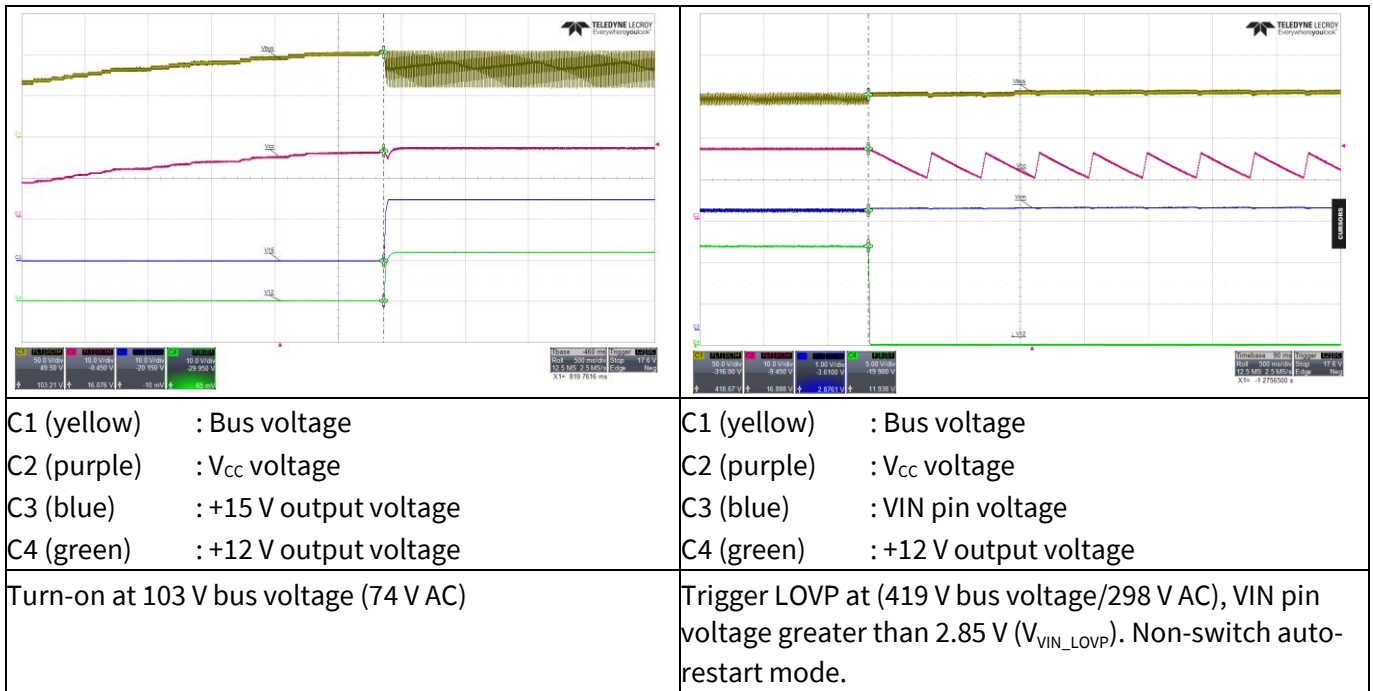

Figure 32 Brown-in and LOVP

15 W auxiliary power supply for invertized air-conditioner using ICE5AR4770AG



Appendix A: Transformer design and spreadsheet [3]

11 Appendix A: Transformer design and spreadsheet [3]

Calculation tool for FF flyback converter using fifth-generation CoolSET™ (version 1.0)

Project:	REF_5AR4770AG_15W1
Application:	AUX for outdoor air-conditioner unit
CoolSET™:	ICE5AR4770AG
Date:	23 Jan 2019
Revision:	V 0.1

Notes:

Enter design variables in orange coloured cells

Read design results in green coloured cells

Equation numbers are according to the design guide

Select component values based on standard values available

Voltage/current rating does not include design margin, voltage spikes and transient currents

In “Output regulation”, only fill in either isolated or non-isolated, whichever is applicable

	Description	Eq. #	Parameter	Unit	Value
Input, output, CoolSET™ specs					
Line input					
Input	Minimum AC input voltage		V_{ACMin}	[V]	85
Input	Maximum AC input voltage		V_{ACMax}	[V]	264
Input	Line frequency		f_{AC}	[Hz]	60
Input	Bus capacitor DC ripple voltage		$V_{DCRipple}$	[V]	36
Output 1 specs					
Input	Output voltage 1		V_{Out1}	[V]	12
Input	Output current 1		I_{Out1}	[A]	1
Input	Forward voltage of output diode 1		V_{FOut1}	[V]	0.6
Input	Output ripple voltage 1		$V_{OutRipple1}$	[V]	0.3
Result	Output power 1	Eq. 001	P_{Out1}	[W]	12
Result	Output load weight 1	Eq. 004	K_{L1}		0.82
Output 2 specs					
Input	Output voltage 2		V_{Out2}	[V]	18
Input	Output current 2		I_{Out2}	[A]	0.15
Input	Forward voltage of output diode 2		V_{FOut2}	[V]	0.6
Input	Output ripple voltage 2		$V_{OutRipple2}$	[V]	0.3
Result	Output power 2	Eq. 002	P_{Out2}	[W]	2.7
Result	Output load weight 2	Eq. 005	K_{L2}		0.18
Auxiliary					
Input	V_{CC} voltage		V_{Vcc}	[V]	18
Input	Forward voltage of V_{CC} diode (D2)		V_{FVcc}	[V]	0.6
Power					
Input	Efficiency		η		0.84
Result	Nominal output power	Eq. 003	P_{OutNom}	[W]	14.70
Input	Maximum output power for over-load protection		P_{OutMax}	[W]	16
Result	Maximum input power for over-load protection	Eq. 006	P_{InMax}	[W]	19.25
Input	Minimum output power		P_{OutMin}	[W]	1.6
Controller/CoolSET™					
	Controller/CoolSET™				ICE5AR4770AG
Input	Switching frequency		f_s	[Hz]	100000
Input	Targeted max. drain source voltage		V_{DSMax}	[V]	600

15 W auxiliary power supply for invertized air-conditioner using ICE5AR4770AG



Appendix A: Transformer design and spreadsheet [3]

Input	Max. ambient temperature		T_{amax}	[°C]	50
-------	--------------------------	--	-------------------	------	----

Diode bridge and input capacitor

Diode bridge

Input	Power factor		$\cos\phi$		0.6
Result	Maximum AC input current	Eq. 007	I_{ACRMS}	[A]	0.377
Result	Peak voltage at V_{ACmax}	Eq. 008	V_{DCmaxPk}	[V]	373.35

Input capacitor

Result	Peak voltage at V_{ACmin}	Eq. 009	V_{DCminPk}	[V]	120.21
Result	Selected minimum DC input voltage	Eq. 010	V_{DCminSet}	[V]	84.21
Result	Discharging time at each half-line cycle	Eq. 011	T_D	[ms]	6.23
Result	Required energy at discharging time of input capacitor	Eq. 012	W_{in}	[Ws]	0.12
Result	Calculated input capacitor	Eq. 013	C_{INcal}	[μF]	32.57
Input	Select input capacitor (C1)		C_{in}	[μF]	33
Result	Calculated minimum DC input voltage	Eq. 015	V_{DCmin}	[V]	84.78

Transformer design

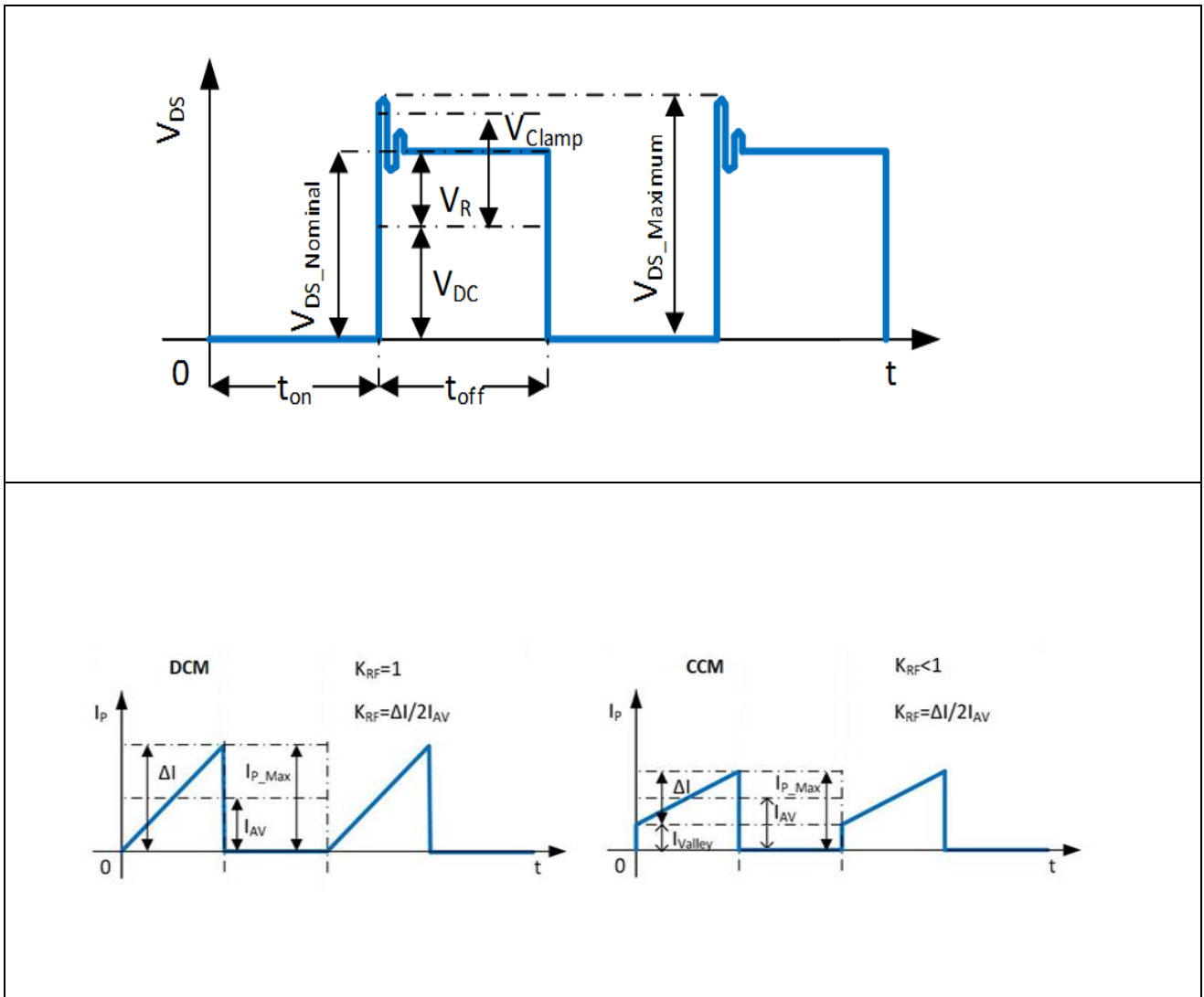

Figure 33 Drain voltage and current waveform

15 W auxiliary power supply for invertized air-conditioner using ICE5AR4770AG



Appendix A: Transformer design and spreadsheet [3]

Primary inductance and winding currents

Input	Reflection voltage		V_{RSET}	[V]	100.8
Result	Maximum duty cycle	Eq. 016	D_{Max}		0.54
Input	Select current ripple factor		K_{RF}		1
Result	Primary inductance	Eq. 017	L_P	[H]	5.51E-04
Result	Primary turn-on average current	Eq. 018	I_{AV}	[A]	0.42
Result	Primary peak-to-peak current	Eq. 019	ΔI	[A]	0.84
Result	Primary peak current	Eq. 020	I_{PMax}	[A]	0.84
Result	Primary valley current	Eq. 021	I_{Valley}	[A]	0.00
Result	Primary RMS current	Eq. 022	I_{PRMS}	[A]	0.356

Select core type

Input	Select core type				10
Result	Core type				EE20/10/6
Result	Core material				TP4A(TDG)
Result	Maximum flux density		B_{Max}	[T]	0.25
Result	Cross-sectional area		A_e	[mm ²]	32
Result	Bobbin width		BW	[mm]	11
Result	Winding cross-section		A_N	[mm ²]	34
Result	Average length of turn		l_N	[mm]	41.2

Winding calculation

Result	Calculated minimum number of primary turns	Eq. 023	N_{PCal}	Turns	57.56
Input	Select number of primary turns		N_P	Turns	64
Result	Calculated number of secondary 1 turns	Eq. 024	N_{S1Cal}	Turns	8.00
Input	Select number of secondary 1 turns		N_{S1}	Turns	8
Result	Calculated number of secondary 2 turns	Eq. 025	N_{S2Cal}	Turns	11.81
Input	Select number of secondary 2 turns		N_{S2}	Turns	12
Result	Calculated number of auxiliary turns	Eq. 026	N_{VccCal}	Turns	11.81
Input	Select number of auxiliary turns		N_{Vcc}	Turns	11
Result	Calculated V_{cc} voltage	Eq. 027	V_{VccCal}	[V]	16.73

Post calculation

Result	Primary to secondary 1 turns ratio	Eq. 028	N_{PS1}		8.00
Result	Primary to secondary 2 turns ratio	Eq. 029	N_{PS2}		5.33
Result	Post-calculated reflected voltage	Eq. 030	V_{RPost}	[V]	100.80
Result	Post-calculated maximum duty cycle	Eq. 031	$D_{MaxPost}$		0.54
Result	Duty cycle prime	Eq. 032	D_{Max}'		0.46
Result	Actual flux density	Eq. 033	B_{MaxAct}	[T]	0.225
Result	Maximum DC input voltage for CCM operation	Eq. 034	$V_{DCmaxCCM}$	[V]	84.78

Transformer winding design

Input	Margin according to safety standard		M	[mm]	0
Input	Copper space factor		f_{Cu}		0.4
Result	Effective bobbin window	Eq. 035	BW_E	[mm]	11.0
Result	Effective winding cross-section	Eq. 036	A_{Ne}	[mm ²]	34.0
Input	Primary winding area factor		AF_{NP}		0.50
Input	Secondary 1 winding area factor		AF_{NS1}		0.30
Input	Secondary 2 winding area factor		AF_{NS2}		0.15
Input	Auxiliary winding area factor		AF_{NVcc}		0.05

15 W auxiliary power supply for invertized air-conditioner using ICE5AR4770AG



Appendix A: Transformer design and spreadsheet [3]

Primary winding

Result	Calculated copper wire cross-sectional area	Eq. 037	A_{PCal}	[mm ²]	0.1063
Result	Calculated maximum wire size	Eq. 038	AWG_{PCal}		27
Input	Select wire size		AWG_P		29
Input	Select number of parallel wire		n_{WP}		1
Result	Copper wire diameter	Eq. 039	d_P	[mm]	0.29
Result	Copper wire cross-sectional area	Eq. 040	A_P	[mm ²]	0.0652
Result	Wire current density	Eq. 041	S_P	[A/mm ²]	5.46
Input	Insulation thickness		INS_P	[mm]	0.01
Result	Turns per layer	Eq. 042	NL_P	Turns/layer	35
Result	Number of layers	Eq. 043	LN_P	Layers	2

Secondary 1 winding

Result	Calculated copper wire cross-sectional area	Eq. 044	A_{NS1Cal}	[mm ²]	0.5100
Result	Calculated maximum wire size	Eq. 045	AWG_{S1Cal}		20
Input	Select wire size		AWG_{S1}		31
Input	Select number of parallel wire		n_{WS1}		7
Result	Copper wire diameter	Eq. 046	d_{S1}	[mm]	0.2287
Result	Copper wire cross-sectional area	Eq. 047	A_{S1}	[mm ²]	0.2874
Result	Peak current	Eq. 048	I_{S1Max}	[A]	5.4601
Result	RMS current	Eq. 049	I_{S1RMS}	[A]	2.1307
Result	Wire current density	Eq. 050	S_{S1}	[A/mm ²]	7.41
Input	Insulation thickness		INS_{S1}	[mm]	0.01
Result	Turns per layer	Eq. 051	NL_{S1}	Turns/layer	6
Result	Number of layers	Eq. 052	LN_{S1}	Layers	2

Secondary 2 winding

Result	Calculated copper wire cross-sectional area	Eq. 053	A_{NS2Cal}	[mm ²]	0.1700
Result	Calculated maximum wire size	Eq. 054	AWG_{S2Cal}		25
Input	Select wire size		AWG_{S2}		34
Input	Select number of parallel wire		n_{WS2}		4
Result	Copper wire diameter	Eq. 055	d_{S2}	[mm]	0.1617
Result	Copper wire cross-sectional area	Eq. 056	A_{S2}	[mm ²]	0.0822
Result	Peak current	Eq. 057	I_{S2Max}	[A]	0.8190
Result	RMS current	Eq. 058	I_{S2RMS}	[A]	0.3196
Result	Wire current density	Eq. 059	S_{S2}	[A/mm ²]	3.89
Input	Insulation thickness		INS_{S2}	[mm]	0.01
Result	Turns per layer	Eq. 060	NL_{S2}	Turns/layer	15
Result	Number of layers	Eq. 061	LN_{S2}	Layers	1

RCD clamper and CS resistor

RCD clamper circuit

Input	Leakage inductance percentage		$L_{LK\%}$	[%]	0.26
Result	Leakage inductance	Eq. 062	L_{LK}	[H]	1.43E-06
Result	Clamping voltage	Eq. 063	V_{Clamp}	[V]	125.85
Result	Calculated clamping capacitor	Eq. 064	$C_{ClampCal}$	[nF]	0.04
Input	Select clamping capacitor value (C2)		C_{Clamp}	[nF]	1
Result	Calculated clamping resistor	Eq. 065	$R_{ClampCal}$	[k Ω]	823.3
Input	Select clamping resistor value (R4)		R_{Clamp}	[k Ω]	820

15 W auxiliary power supply for invertized air-conditioner using ICE5AR4770AG



Appendix A: Transformer design and spreadsheet [3]

CS resistor

Input	CS threshold value from datasheet		V_{CS_N}	[V]	0.8
Result	Calculated CS resistor (R8A, R8B)	Eq. 066	R_{sense}	[Ω]	0.96

Output rectifier

Secondary 1 output rectifier

Result	Diode reverse voltage	Eq. 067	$V_{RDiode1}$	[V]	58.67
Result	Diode RMS current		I_{S1RMS}	[A]	2.13
Input	Max. voltage undershoot at output capacitor		ΔV_{Out1}	[V]	0.3
Input	Number of clock periods		n_{cp1}		20
Result	Output capacitor ripple current	Eq. 068	$I_{Ripple1}$	[A]	1.88
Result	Calculated minimum output capacitor	Eq. 069	$C_{Out1Cal}$	[μ F]	667
Input	Select output capacitor value (C152)		C_{Out1}	[μ F]	820
Input	ESR (Zmax) value from datasheet at 100 kHz		R_{ESR1}	[Ω]	0.041
Input	Number of parallel capacitors		n_{CCout1}		1
Result	Zero frequency of output capacitor	Eq. 070	f_{zCOut1}	[kHz]	4.73
Result	First-stage ripple voltage	Eq. 071	$V_{Ripple1}$	[V]	0.223865
Input	Select LC filter inductor value (L151)		L_{out1}	[μ H]	4.7
Result	Calculated LC filter capacitor	Eq. 072	C_{LCCal1}	[μ F]	240.5
Input	Select LC filter capacitor value (C153)		C_{LC1}	[μ F]	220
Result	LC filter frequency	Eq. 073	f_{LC1}	[kHz]	4.95
Result	Second-stage ripple voltage	Eq. 074	$V_{2ndRipple1}$	[mV]	0.55

Secondary 2 output rectifier

Result	Diode reverse voltage	Eq. 075	$V_{RDiode2}$	[V]	88.00
Result	Diode RMS current		I_{S2RMS}	[A]	0.32
Input	Max. voltage undershoot at output capacitor		ΔV_{Out1}	[V]	0.3
Input	Number of clock periods		n_{cp2}		20
Result	Output capacitor ripple current	Eq. 076	$I_{Ripple2}$	[A]	0.28
Result	Calculated minimum output capacitor	Eq. 077	$C_{Out2Cal}$	[μ F]	100
Input	Select output capacitor value (C152)		C_{Out2}	[μ F]	220
Input	ESR (Zmax) value from datasheet at 100 kHz		R_{ESR2}	[Ω]	0.15
Input	Number of parallel capacitors		n_{CCout2}		1

V_{CC} diode and capacitor

V_{CC} diode and capacitor

Result	Auxiliary diode reverse voltage (D2)	Eq. 083	$V_{RDiodeVCC}$	[V]	80.89
Input	Soft-start time from datasheet		t_{ss}	[ms]	12
Input	$I_{VCC_Charge3}$ from datasheet		$I_{VCC_Charge3}$	[mA]	3
Input	V _{CC} on-threshold		V_{VCC_ON}	[V]	16
Input	V _{CC} off-threshold		V_{VCC_OFF}	[V]	10
Result	Calculated V _{CC} capacitor	Eq. 084	C_{VCCCal}	[μ F]	6.00
Input	Select V _{CC} capacitor (C3)		C_{VCC}	[μ F]	22
Input	V _{CC} short threshold from datasheet		V_{VCC_SCP}	[V]	1.1
Input	$I_{VCC_Charge1}$ from datasheet		$I_{VCC_Charge1}$	[mA]	0.2
Result	Start-up time	Eq. 085	$t_{StartUp}$	[ms]	230.267

Calculation of losses

Input diode bridge

Input	Diode bridge forward voltage		V_{FBR}	[V]	1
Result	Diode bridge power loss	Eq. 086	P_{DIN}	[W]	0.75

Transformer copper

Result	Primary winding copper resistance	Eq. 087	R_{PCu}	[m Ω]	695.89
--------	-----------------------------------	---------	-----------	---------------	--------

15 W auxiliary power supply for invertized air-conditioner using ICE5AR4770AG



Appendix A: Transformer design and spreadsheet [3]

Result	Secondary 1 winding copper resistance	Eq. 088	R_{S1Cu}	[m Ω]	19.72
Result	Secondary 2 winding copper resistance	Eq. 089	R_{S2Cu}	[m Ω]	103.51
Result	Primary winding copper loss	Eq. 090	P_{PCu}	[mW]	88.08
Result	Secondary 1 winding copper loss	Eq. 091	P_{S1Cu}	[mW]	89.53
Result	Secondary 2 winding copper loss	Eq. 092	P_{S2Cu}	[mW]	10.57
Result	Total transformer copper loss	Eq. 093	P_{Cu}	[W]	0.1882

Output rectifier diode

Result	Secondary 1 diode loss	Eq. 094	P_{Diode1}	[W]	1.28
Result	Secondary 2 diode loss	Eq. 095	P_{Diode2}	[W]	0.19

RCD clamper circuit

Result	RCD clamper loss	Eq. 096	$P_{Clamper}$	[W]	0.09
--------	------------------	---------	---------------	-----	------

CS resistor

Result	CS resistor loss	Eq. 097	P_{CS}	[W]	0.12
--------	------------------	---------	----------	-----	------

MOSFET

Input	$R_{DS(on)}$ from datasheet		$R_{DS(on)}$ at $T_A = 125^\circ\text{C}$	[Ω]	8.73
Input	$C_{o(er)}$ from datasheet		$C_{o(er)}$	[pF]	3.4
Input	External drain-to-source capacitance		C_{DS}	[pF]	0
Result	Switch-on loss at minimum AC input voltage	Eq. 098	$P_{SONMinAC}$	[W]	0.0059
Result	Conduction loss at minimum AC input voltage	Eq. 099	$P_{condMinAC}$	[W]	1.1049
Result	Total MOSFET loss at minimum AC input voltage	Eq. 100	$P_{MOSMinAC}$	[W]	1.1108
Result	Switch-on loss at maximum AC input voltage	Eq. 101	$P_{SONMaxAC}$	[W]	0.0382
Result	Conduction loss at maximum AC input voltage	Eq. 102	$P_{condMaxAC}$	[W]	0.2509
Result	Total MOSFET loss at maximum AC input voltage	Eq. 103	$P_{MOSMaxAC}$	[W]	0.2891
Result	Total MOSFET loss (from minimum or maximum AC)		P_{MOS}	[W]	1.1108

Controller

Input	Controller current consumption		I_{VCC_Normal}	[mA]	0.9
Result	Controller loss	Eq. 104	P_{Ctrl}	[W]	0.0151

Efficiency after losses

Result	Total power loss	Eq. 105	P_{Losses}	[W]	3.75
Result	Post calculated efficiency	Eq. 106	η_{Post}	%	81.17 percent

CoolSET™/MOSFET temperature

CoolSET™/MOSFET temperature

Input	Enter thermal resistance junction-ambient (include copper pour)		R_{thJA_As}	[$^\circ\text{K/W}$]	65.0
Result	Temperature rise	Eq. 107	ΔT	[$^\circ\text{K}$]	72.2
Result	Junction temperature at T_{amax}	Eq. 108	T_{jmax}	$^\circ\text{C}$	122.2

Line OVP

Line OVP

Input	Select AC input LOVP		V_{OVP_AC}	[V AC]	300
Input	High-side DC input voltage divider/resistor (R3A, R3B, R3C)		R_{I1}	[M Ω]	16
Input	Controller LOVP threshold		V_{VIN_LOVP}	[V]	2.85
Result	Low-side DC input voltage divider/resistor	Eq. 109	R_{I2Cal}	[k Ω]	108.88
Input	Select low-side DC input voltage divider/resistor (R7)		R_{I2}	[k Ω]	110
Result	Post-calculated LOVP	Eq. 110	V_{OVP_ACPost}	[V AC]	296.98

Output regulation (isolated using TL431 and optocoupler)

Isolated feedback circuit

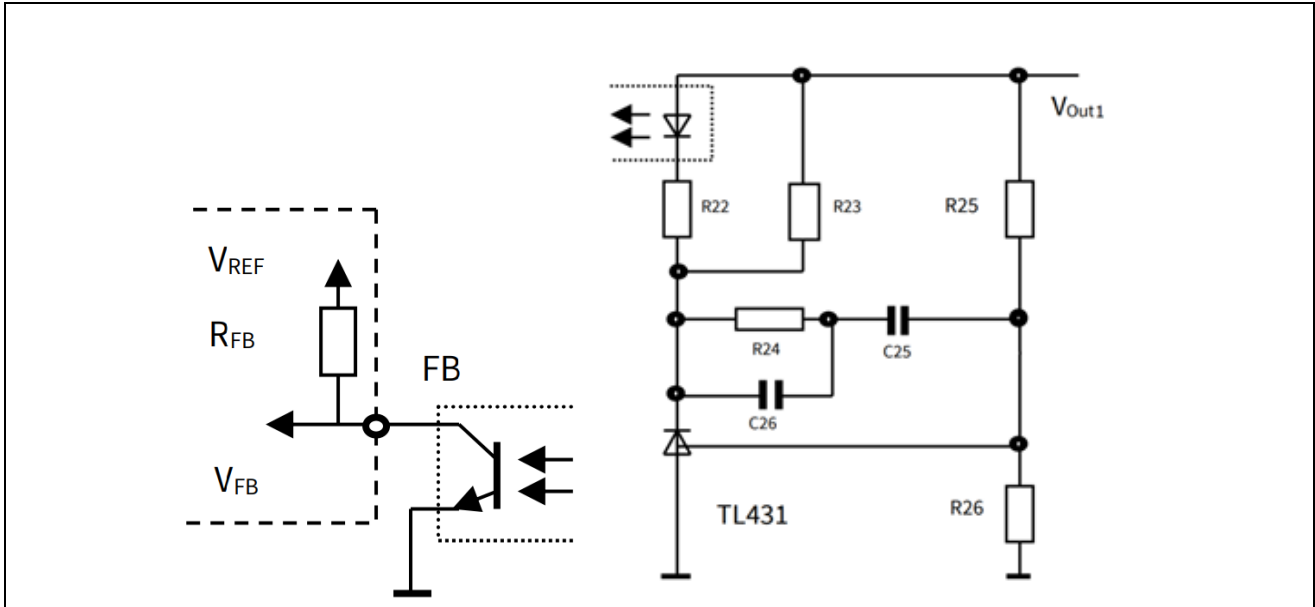

Output regulation

Input	TL431 reference voltage		V_{REF_TL}	[V]	2.5
Input	Current for voltage divider/resistor R26		I_{R26}	[mA]	1
Result	Calculated voltage divider/resistor	Eq. 111	$R26_{cal}$	[k Ω]	0.25
Input	Select voltage divider/resistor value		R26	[k Ω]	10
Result	Calculated voltage divider/resistor	Eq. 112	$R25_{cal}$	[k Ω]	38.00
Input	Select voltage divider/resistor value		R25	[k Ω]	38.0

Optocoupler and TL431 bias

Input	Current Transfer Ratio (CTR)		G_C	[Percent]	100 percent
Input	Optocoupler diode forward voltage		V_{FOpto}	[V]	1.25
Input	Maximum current for optocoupler diode		I_{Fmax}	[mA]	10
Input	Minimum current for TL431		I_{KAmin}	[mA]	1
Result	Calculated minimum optocoupler bias resistance	Eq. 114	$R22_{cal}$	[k Ω]	0.825
Input	Select optocoupler bias resistor		R22	[k Ω]	0.82
Input	FB pull-up reference voltage V_{REF} from datasheet		V_{REF}	[V]	3.3
Input	V_{FB_OLP} from datasheet		V_{FB_OLP}	[V]	2.75
Input	R_{FB} from datasheet		R_{FB}	[k Ω]	15
Result	Calculated maximum TL431 bias resistance	Eq. 115	$R23_{cal}$	[k Ω]	1.28
Input	Selected TL431 bias resistor		R23	[k Ω]	1.2

Regulation loop

Result	FB transfer characteristic	Eq. 116	K_{FB}		18.29
Result	Gain of FB transfer characteristic	Eq. 117	G_{FB}	[db]	25.25
Result	Voltage divider transfer characteristic	Eq. 118	K_{VD}		0.208333
Result	Gain of voltage divider transfer characteristic	Eq. 119	G_{VD}	[db]	-13.62
Result	Resistance at maximum load pole	Eq. 120	R_{LH}	[Ω]	8.91
Result	Resistance at minimum load pole	Eq. 121	R_{LL}	[Ω]	90
Result	Poles of power stage at maximum load pole	Eq. 122	f_{OH}	[Hz]	43.59
Result	Poles of power stage at minimum load pole	Eq. 123	f_{OL}	[Hz]	4.31
Result	Zero frequency of the compensation network	Eq. 124	f_{OM}	[Hz]	13.71

15 W auxiliary power supply for invertized air-conditioner using ICE5AR4770AG



Appendix A: Transformer design and spreadsheet [3]

Input	Zero dB crossover frequency		f_g	[kHz]	3
Input	PWM-OP gain from datasheet		A_v		2.03
Result	Transient impedance	Eq. 117	Z_{PWR}	[V/A]	2.4
Result	Power stage at crossover frequency	Eq. 118	$ F_{PWR}(f_g) $		0.086
Result	Gain of power stage at crossover frequency	Eq. 119	$G_{PWR}(f_g)$	[db]	-21.32
Result	Gain of the regulation loop at f_g	Eq. 120	$G_S(\omega)$	[db]	-9.701
Result	Separated components of the regulator	Eq. 121	$G_r(\omega)$	[db]	9.701
Result	Calculated resistance value of compensation network	Eq. 122	$R_{24_{Cal}}$	[k Ω]	24.19
Input	Select resistor value of compensation network		R24	[k Ω]	20
Result	Calculated capacitance value of compensation network	Eq. 123	$C_{26_{Cal}}$	[nF]	2.653
Input	Select capacitor value of compensation network		C26	[nF]	1
Result	Calculated capacitance value of compensation network	Eq. 124	$C_{25_{Cal}}$	[nF]	579.37
Input	Select capacitor value of compensation network		C25	[nF]	390

Output regulation (non-isolated)

Final design

Electrical

Minimum AC voltage			[V]	85
Maximum AC voltage			[V]	264
Maximum input current			[A]	0.23
Minimum DC voltage			[V]	85
Maximum DC voltage			[V]	373
Maximum output power			[W]	16.2
Output voltage 1			[V]	12.0
Output ripple voltage 1			[mV]	0.5
Output voltage 1			[V]	18.0
Output ripple voltage 1			[mV]	0.3
Transformer peak current			[A]	0.84
Maximum duty cycle				0.54
Reflected voltage			[V]	101
Copper losses			[W]	0.19
MOSFET losses			[W]	1.11
Sum losses			[W]	4.16
				79.55
Efficiency			[Percent]	percent

Transformer

Core type				EE20/10/6
Core material				TP4A(TDG)
Effective core area			[mm ²]	32
Maximum flux density			[mT]	225
Inductance			[μ H]	551
Margin			[mm]	0
Primary turns			Turns	64
Primary copper wire size			AWG	29
Number of primary copper wires in parallel				1
Primary layers			Layer	2
Secondary 1 turns (N_{S1})			Turns	8
Secondary 1 copper wire size			AWG	31
Number of secondary 1 copper wires in parallel				7
Secondary 1 layers			Layer	2
Auxiliary turns			Turns	12
Leakage inductance			[μ H]	34

Components

Input capacitor (C1)			[μ F]	33.0
Secondary 1 output capacitor (C152)			[μ F]	820.0
Secondary 1 output capacitor in parallel				1.0
Secondary 1 LC filter inductor (L151)			[μ H]	4.7
Secondary 1 LC filter capacitor (C153)			[μ F]	220.0
V _{CC} capacitor (C3)			[μ F]	220.0

15 W auxiliary power supply for invertized air-conditioner using ICE5AR4770AG



Appendix A: Transformer design and spreadsheet [3]

Sense resistor (R8A, R8B)			[Ω]	1.0
Clamping resistor (R4)			[k Ω]	4.7
Clamping capacitor (C2)			[nF]	220.0
High-side DC input voltage divider/resistor (R3A, R3B, R3C)			[M Ω]	22.0
Low-side DC input voltage divider/resistor (R7)			[k Ω]	0.96

Regulation components (isolated using TL431 and optocoupler)

Voltage divider		R26	[k Ω]	10
Voltage divider (V_{OUT1} sense)		R25	[k Ω]	38
Optocoupler bias resistor		R22	[k Ω]	0.82
TL431 bias resistor		R23	[k Ω]	1.2
Compensation network resistor		R24	[k Ω]	20
Compensation network capacitor		C26	[nF]	1.0
Compensation network capacitor		C25	[nF]	390

15 W auxiliary power supply for invertized air-conditioner using ICE5AR4770AG

Appendix B: WE transformer specification

12 Appendix B: WE transformer specification

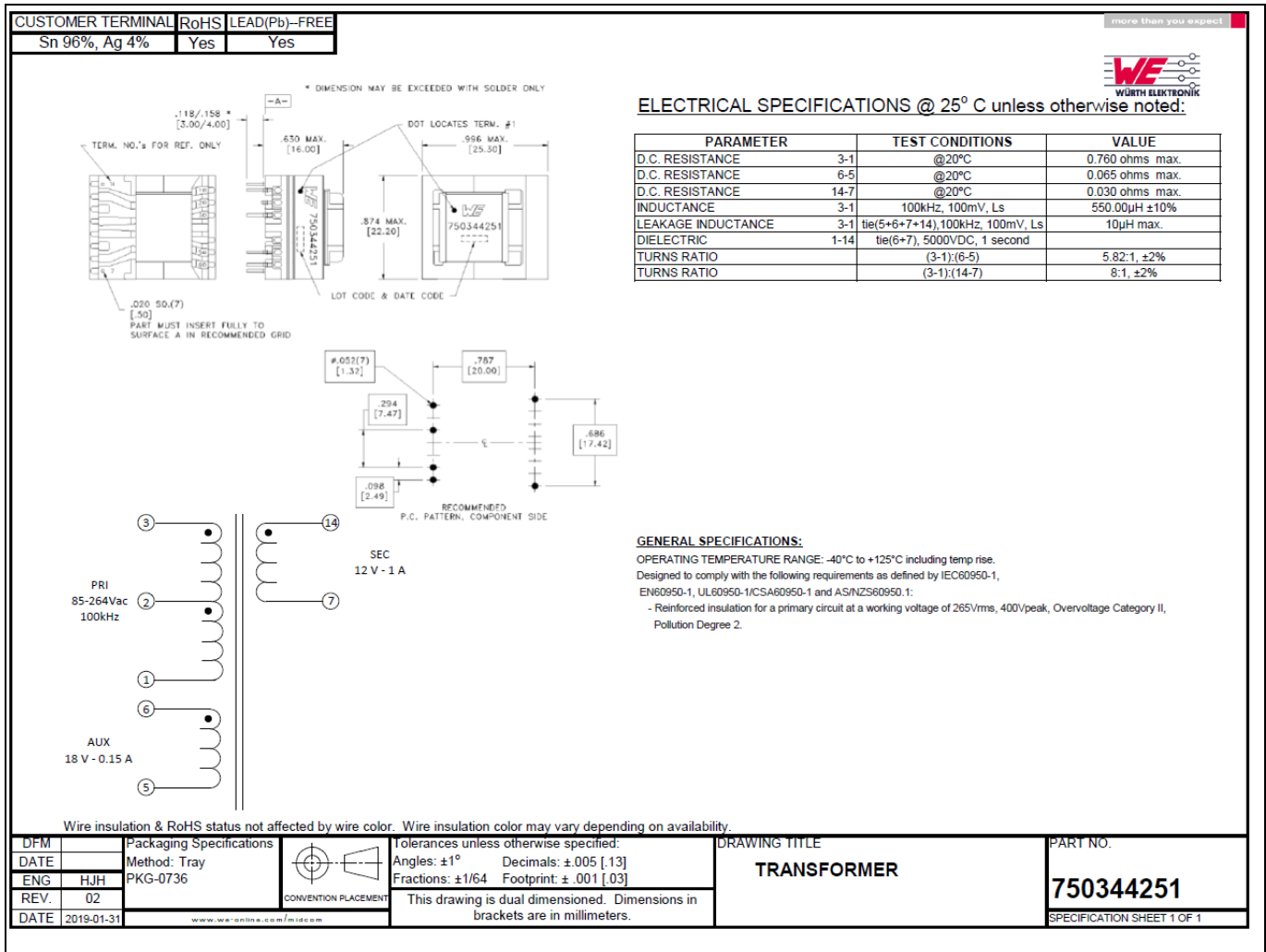

Figure 34 WE transformer specification

References

13 References

- [1] [ICE5AR4770AG datasheet, Infineon Technologies AG](#)
- [2] [5th-Generation Fixed-Frequency Design Guide](#)
- [3] [CalculationTool ICE5xSAG ICE5xRxxxxAG](#)

Revision history

Revision history

Document version	Date of release	Description of changes
V 1.0	12 Feb. 2019	First release
V 1.1	20 Jan. 2021	Page 7, circuit diagram Update schematic Page 10, table 3 Update protection

Trademarks

All referenced product or service names and trademarks are the property of their respective owners.

Edition 2021-01-20

Published by

Infineon Technologies AG

81726 Munich, Germany

© 2021 Infineon Technologies AG.

All Rights Reserved.

Do you have a question about this document?

Email: erratum@infineon.com

Document reference

AN_1901_PL83_1902_074332

IMPORTANT NOTICE

The information contained in this application note is given as a hint for the implementation of the product only and shall in no event be regarded as a description or warranty of a certain functionality, condition or quality of the product. Before implementation of the product, the recipient of this application note must verify any function and other technical information given herein in the real application. Infineon Technologies hereby disclaims any and all warranties and liabilities of any kind (including without limitation warranties of non-infringement of intellectual property rights of any third party) with respect to any and all information given in this application note.

The data contained in this document is exclusively intended for technically trained staff. It is the responsibility of customer's technical departments to evaluate the suitability of the product for the intended application and the completeness of the product information given in this document with respect to such application.

For further information on the product, technology, delivery terms and conditions and prices please contact your nearest Infineon Technologies office (www.infineon.com).

WARNINGS

Due to technical requirements products may contain dangerous substances. For information on the types in question please contact your nearest Infineon Technologies office.

Except as otherwise explicitly approved by Infineon Technologies in a written document signed by authorized representatives of Infineon Technologies, Infineon Technologies' products may not be used in any applications where a failure of the product or any consequences of the use thereof can reasonably be expected to result in personal injury.