

# 24 W 12 V 5 V SMPS demo board with ICE5QR2280AZ

## About this document

### Scope and purpose

This document is an engineering report that describes a universal input 24 W, 12 V and 5 V off-line flyback converter using the newest 5<sup>th</sup> generation Infineon QR CoolSET™ [ICE5QR2280AZ](#) which offers high efficiency, low standby power with selectable entry and exit standby power options, wider VCC operating range with fast start up, robust line protection with input OVP and brownout and various modes of protection for a highly reliable system. This demo board is designed for users who wish to evaluate the performance of ICE5QR2280AZ and its ease of use.

### Intended audience

This document is intended for power supply design engineers, application engineers, students, etc., who wish to design a low cost and highly reliable off-line SMPS. This can be an auxiliary power supply for white goods, PC, server and TV or an enclosed adapter for a blu-ray player, set-top box, game console, etc.

## Table of contents

|   |           |
|---|-----------|
| <b>About this document</b> .....            | <b>1</b>  |
| <b>Table of contents</b> .....              | <b>1</b>  |
| <b>1 Abstract</b> .....                     | <b>3</b>  |
| <b>2 Demo board</b> .....                   | <b>4</b>  |
| <b>3 Specifications of demo board</b> ..... | <b>5</b>  |
| <b>4 Circuit description</b> .....          | <b>6</b>  |
| 4.1 Line input.....                         | 6         |
| 4.2 Start-up.....                           | 6         |
| 4.3 Integrated MOSFET and PWM control ..... | 6         |
| 4.4 RCD clamper circuit.....                | 6         |
| 4.5 Output stage.....                       | 6         |
| 4.6 Feedback loop .....                     | 6         |
| 4.7 Primary side peak current control.....  | 6         |
| 4.8 Digital frequency reduction .....       | 7         |
| 4.9 Active burst mode .....                 | 7         |
| <b>5 Protection features</b> .....          | <b>8</b>  |
| <b>6 Circuit diagram</b> .....              | <b>9</b>  |
| <b>7 PCB layout</b> .....                   | <b>10</b> |
| 7.1 Top side .....                          | 10        |
| 7.2 Bottom side .....                       | 10        |
| <b>8 BOM</b> .....                          | <b>11</b> |
| <b>9 Transformer construction</b> .....     | <b>13</b> |
| <b>10 Test results</b> .....                | <b>14</b> |

**Abstract**

10.1 Efficiency, regulation and output ripple ..... 14

10.2 Standby power ..... 15

10.3 Line regulation ..... 16

10.4 Load regulation ..... 17

10.5 Maximum input power ..... 18

10.6 ESD immunity (EN61000-4-2)..... 18

10.7 Surge immunity (EN61000-4-5)..... 18

10.8 Conducted emissions (EN55022 class B) ..... 18

10.9 Thermal measurement ..... 21

**11 Waveforms and oscilloscope plots .....22**

11.1 Start-up at low/high AC line input voltage with maximum load..... 22

11.2 Soft-start..... 22

11.3 Drain and current sense voltage at maximum load..... 23

11.4 Zero crossing point during normal operation..... 23

11.5 Load transient response (dynamic load from 10% to 100%) ..... 24

11.6 Output ripple voltage at maximum load..... 24

11.7 Output ripple voltage at burst mode 1 W load..... 25

11.8 Entering active burst mode..... 25

11.9 During active burst mode..... 26

11.10 Leaving active burst mode..... 26

11.11 Line over voltage protection (non switch auto restart) ..... 27

11.12 Brownout protection (non switch auto restart) ..... 27

11.13 V<sub>CC</sub> over-voltage protection (odd skip auto restart)..... 28

11.14 V<sub>CC</sub> under voltage protection (auto restart)..... 28

11.15 Overload protection (odd skip auto restart) ..... 29

11.16 Output over-voltage protection (odd skip auto restart)..... 29

11.17 V<sub>CC</sub> short to GND protection ..... 30

**12 References .....31**

**Revision history .....31**

---

## Abstract

### 1 Abstract

This application note is an engineering report for a 24 W, 12 V and 5 V demo board designed in a QR flyback converter topology using a 5<sup>th</sup> generation QR CoolSET™ device, ICE5QR2280AZ. The target applications for the ICE5QR2280AZ include set top boxes, portable game controllers, blu-ray/DVD players and auxiliary power supplies for home appliances, white goods, PCs, printers, TVs, home theater/audio systems etc. With the CoolMOS™ integrated into this IC, it greatly simplifies the design and layout of the PCB. The improved digital frequency reduction with proprietary QR operation offers lower EMI and higher efficiency for a wide AC range by reducing the switching frequency difference between low- and high-line.

The enhanced active burst mode power enables flexibility in standby power operation range selection and QR operation during active burst mode. As a result, the system efficiency over the entire load range, is significantly improved compared to a conventional free running QR converter implemented with only maximum switching frequency limitation at light load. In addition, numerous adjustable protection functions have been implemented in the ICE5QR2280AZ to protect the system and customize the IC for the chosen application. In the case of a failure mode such as brownout or line over-voltage,  $V_{CC}$  over/under voltage, open control loop or overload, output overvoltage, over temperature,  $V_{CC}$  short to ground and CS short to ground, the device enters a protection mode. By means of the cycle-by-cycle peak current limitation, the dimension of the transformer and current rating of the secondary diode can both be optimized. Thus, a cost effective solution can be easily achieved.

Demo board

## 2 Demo board

This document contains a list of features, the power supply specification, schematic, BOM and the transformer construction documentation. Typical operating characteristics such as the performance curve and oscilloscope waveforms are shown at the end of the report.

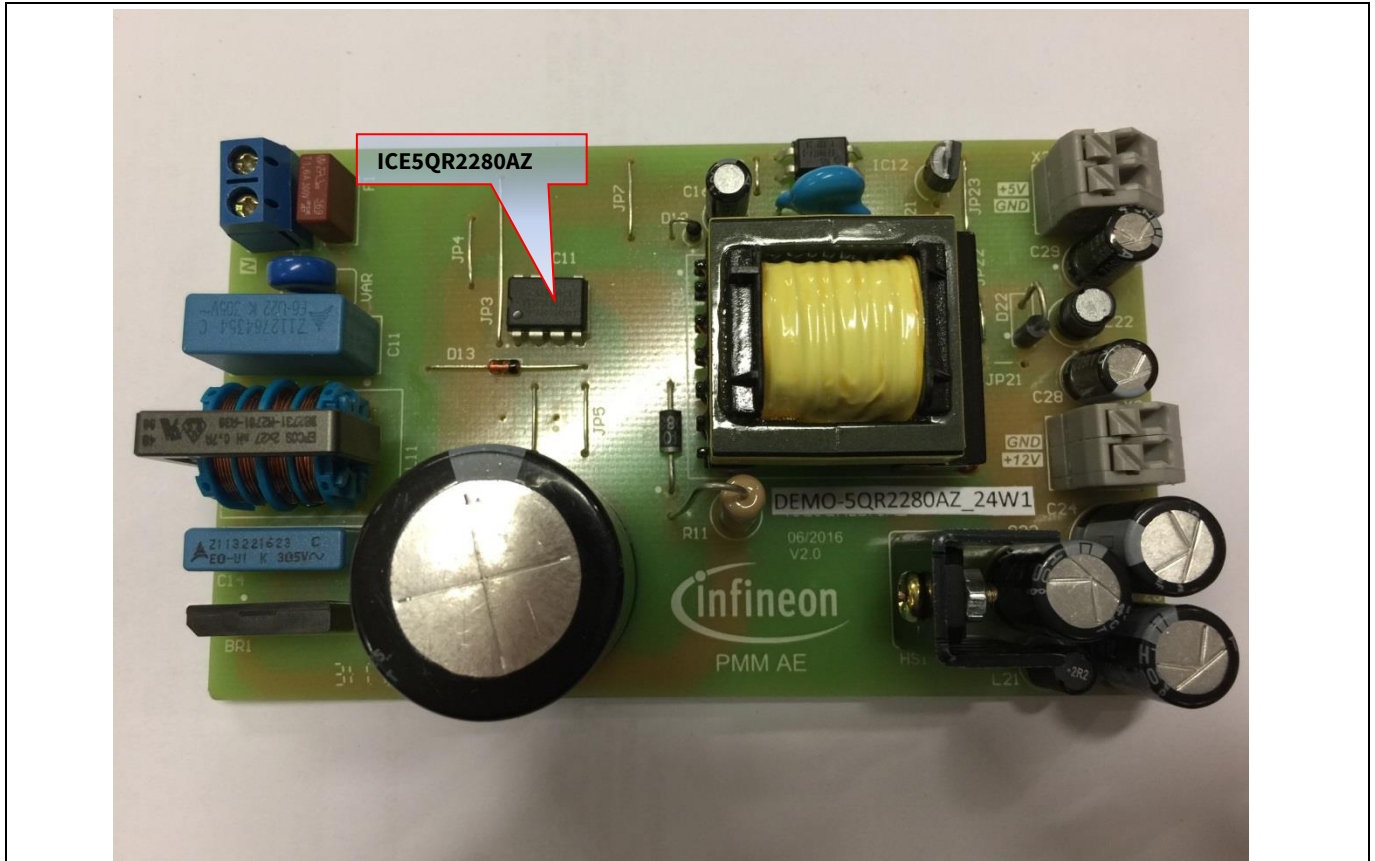

Figure 1 DEMO\_5QR2280AZ\_24W1

---

**Specifications of demo board**

### 3 Specifications of demo board

**Table 1 Specifications of DEMO\_5QR2280AZ\_24W1**

|  |  |
|--|--|
| Input voltage and frequency  | 85 V AC (60 Hz) ~ 300 V AC (50 Hz)   |
| Output voltage, current and power                                    | (12 V x 1.92 A) +(5 V x 0.2 A) = 24 W  |
| Regulation   | +5 V : less than $\pm 5\%$<br>+12 V: less than $\pm 10\%$                            |
| Output ripple voltage<br>(full load, 85 V AC ~ 300 V AC)             | 5 V <sub>ripple_p-p</sub> < 100 mV<br>12 V <sub>ripple_p-p</sub> < 200 mV            |
| Active mode four point average efficiency (25%, 50%, 75%, 100% load) | > 83% at 115 V AC and 230 V AC   |
| No load power consumption  | < 100 mW at 230 V AC   |
| Conducted emissions (EN55022 class B)                                | Pass with 7 dB margin for 115 V AC and 6 dB margin for 230 V AC                      |
| ESD immunity (EN61000-4-2)   | Special level ( $\pm 14$ kV for contact and $6\pm 14$ kV air discharge)              |
| Surge immunity (EN61000-4-5)   | Installation class 4 ( $\pm 2$ kV for line to line and $\pm 4$ kV for line to earth) |
| Form factor case size (L x W x H)                                    | (110 x 66 x 27) mm <sup>3</sup>  |

**Note:** *“The demo board is designed for dual output with cross regulated loop feedback. It may not regulate properly if loading is applied only to a single output. If the user wants to evaluate a single output (12 V only) condition, the following changes are necessary on the board.*

1. Remove D22, L22, C28, C210, R25A (to disable 5 V output)
2. Change R26 to 10 k $\Omega$  and R25 to 38 k $\Omega$  (to disable 5 V feedback and enable 100% weighted factor on 12 V output)

*Since the board (especially the transformer) is designed for dual output with optimized cross regulation, single output efficiency might not be optimized. It is only intended for functional evaluation of the IC under a single output condition.”*

## Circuit description

### 4 Circuit description

#### 4.1 Line input

The AC line input side comprises the input fuse F1 as over-current protection. The choke L11, X-capacitor C11 and Y-capacitor C12 act as EMI suppressors. The sparking gap and varistor VAR can absorb high voltage stress during a lightning surge test. A rectified DC voltage (120~424 V DC) is obtained through the bridge rectifier BR1 together with bulk capacitor C13.

#### 4.2 Start-up

To achieve fast and safe start-up, ICE5QR2280AZ has been implemented with a startup resistor and  $V_{CC}$  short to GND protection. When  $V_{VCC}$  reaches the turn-on voltage threshold of 16 V, the IC begins with a soft-start. The soft-start implemented in ICE5QR2280AZ is a digital time based function. The preset soft-start time is 12 ms with four steps. If not limited by other functions, the peak voltage on the CS pin will increase step by step from 0.3 V to 1 V. After the IC turns on, the  $V_{CC}$  voltage is supplied by the auxiliary windings of the transformer.  $V_{CC}$  short to GND protection is implemented during the startup time.

#### 4.3 Integrated MOSFET and PWM control

[ICE5QR2280AZ](#) comprises a power MOSFET and the proprietary novel QR controller which enables higher average efficiency and low EMI. This integrated solution greatly simplifies the circuit layout and reduces the cost of PCB manufacturing. The PWM switch-on is determined by the zero crossing detection input signal and the value of the up/down counter. The PWM switch-off is determined by the feedback signal  $V_{FB}$  and the current sensing signal  $V_{CS}$ . ICE5QR2280AZ also performs all necessary protection functions in flyback converters. Details about the information mentioned above are contained in the product datasheet.

#### 4.4 RCD clamper circuit

A clamper network (R11, C15 and D11) dissipates the energy of the leakage inductance and suppress ringing on the SMPS transformer.

#### 4.5 Output stage

There are two outputs on the secondary side, 12 V and 5 V. The power is coupled out via schottky diodes D21 and D22. The capacitors C22 and C28 provide energy buffering followed by the LC filters L21-C24 and L22-C210 to reduce the output ripple and prevent interference between the SMPS switching frequency and line frequency considerably. Storage capacitors C22 and C28 are designed to have an internal resistance (ESR) as small as possible to minimize the output voltage ripple caused by the triangular current.

#### 4.6 Feedback loop

For feedback, the output is sensed by the voltage divider of R26, R25, R25A and compared to the IC21 (TL431) internal reference voltage. C25, C26 and R24 comprise the compensation network. The output voltage of IC21 (TL431) is converted to a current signal via optocoupler IC12 and two resistors R22 and R23 for regulation control.

#### 4.7 Primary side peak current control

The MOSFET drain source current is sensed via external resistors R14 and R14A. Since ICE5QR2280AZ is a current mode controller, it would have a cycle-by-cycle primary current and feedback voltage control which can ensure that the maximum power of the converter is controlled in every switching cycle.

## Circuit description

For a QR flyback converter, the maximum possible output power is increased when a constant current limit value is used for all of the line input voltage range. This is usually not desired as this will increase the cost of the transformer and output diode in case of output over power conditions.

Internal current limitation with a line dependent  $V_{CS}$  curve and the proprietary novel QR switching which reduces the switching frequency difference between minimum and maximum line are implemented in the ICE5QR2280AZ. As a result, the maximum output power can be properly limited against the input voltage.

### 4.8 Digital frequency reduction

During normal operation, the switching frequency for ICE5QR2280AZ is digitally reduced with decreasing load. At light load, the MOSFET will be turned on not at the first minimum drain-source voltage time, but on the  $n^{\text{th}}$ . The counter is in the range of one to eight for low line and three to ten for high line, which depends on the feedback voltage in a time-base. The feedback voltage decreases when the output power requirement decreases, and vice-versa. Therefore, the counter is set by monitoring voltage  $V_{FB}$ . The counter will be increased with low  $V_{FB}$  and decreased with high  $V_{FB}$ . The thresholds are preset inside the IC.

### 4.9 Active burst mode

Active burst mode entry and exit power (two levels) can be selected in ICE5QR2280AZ. Details are contained in the product datasheet. At light load conditions, the SMPS enters into active burst mode with QR switching. At this stage, the controller is always active but  $V_{VCC}$  must remain above the switch-off threshold. During active burst mode, the efficiency increases significantly and at the same time it supports low ripple on  $V_{out}$  and fast response on load jump.

For determination of entering active burst mode operation, three conditions apply:

1. the feedback voltage is lower than the threshold of  $V_{FBEB}$
2. the up/down counter is eight for low line and ten for high line and
3. a certain blanking time ( $t_{BEB}=20$  ms).

Once all of these conditions are fulfilled, the active burst mode flip-flop is set and the controller enters active burst mode operation. This multi condition determination for entering active burst mode operation prevents mis-triggering of entering active burst mode operation, so that the controller enters active burst mode operation only when the output power is really low during the preset blanking time.

During active burst mode, the maximum current sense voltage is reduced from 1 V to 0.31/0.35 V so as to reduce the conduction loss and the audible noise. During burst mode, the feedback (FB) voltage represents a sawtooth between 2 V and 2.4 V.

The feedback voltage immediately increases if there is a high load jump. This is observed by one comparator. As the current limit is 31/35% during active burst mode a certain load is needed so that the FB voltage can exceed  $V_{FBLB}$  (2.75 V). After leaving active burst mode, maximum current can now be provided to stabilize  $V_{out}$ . In addition, the up/down counter will be set to one (low line) or three (high line) immediately after leaving active burst mode. This is helpful to decrease the output voltage undershoot.

---

**Protection features**

## 5 Protection features

Protection is one of the major factors to determine whether the system is safe and robust. Therefore sufficient protection is necessary. ICE5QR2280AZ provides a comprehensive protection to ensure the system is operating safely. The protections include line over-voltage, brownout,  $V_{CC}$  over-voltage and under voltage, overload, output over-voltage, over temperature (controller junction), CS short to GND and  $V_{CC}$  short to GND. When those faults are found, the system will go into the protection mode. It is then until the fault is removed, the system resumes to normal operation. A list of protections and the failure conditions are shown in the below table.

**Table 2 Protection functions of ICE5QR2280AZ**

| Protection function  | Failure condition   | Protection mode         |
|--|---|-------------------------|
| Line over-voltage  | $V_{VIN} > 2.9 \text{ V}$   | Non switch auto restart |
| Brownout   | $V_{VIN} < 0.4 \text{ V}$   | Non switch auto restart |
| $V_{CC}$ over-voltage  | $V_{VCC} > 25 \text{ V}$  | Odd skip auto restart   |
| $V_{CC}$ under voltage   | $V_{VCC} < 10 \text{ V}$  | Auto restart            |
| Overload   | $V_{FB} > 2.75 \text{ V}$ & last for 30 ms  | Odd skip auto restart   |
| Output over-voltage  | $V_{ZCD} > 2 \text{ V}$ & last for 10 consecutive pulses                            | Odd skip auto restart   |
| Over temperature (junction temperature of controller chip only )   | $T_J > 140 \text{ }^\circ\text{C}$  | Non switch auto restart |
| CS short to GND  | $V_{CS} < 0.1 \text{ V}$ , lasting for 5 $\mu\text{s}$ and three consecutive pulses | Odd skip auto restart   |
| $V_{CC}$ short to GND<br>( $V_{VCC}=0 \text{ V}$ , $R_{StartUp}=50 \text{ m}\Omega$ and $V_{DRAIN}=90 \text{ V}$ ) | $V_{VCC} < 1.2 \text{ V}$ , $I_{VCC\_Charge1} \approx 0.2 \text{ A}$                | Cannot start-up         |



Circuit diagram

## 6 Circuit diagram

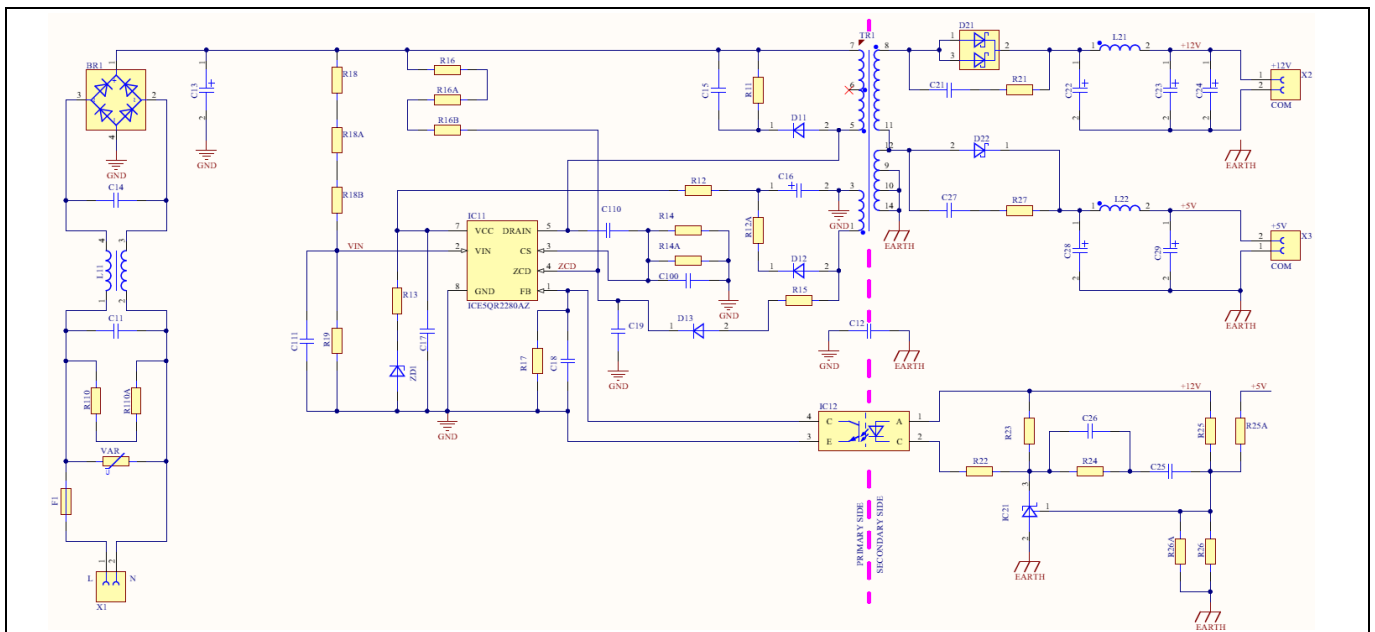

**Figure 2 Schematic of DEMO\_5QR2280AZ\_24W1**

Note: General guidelines for layout of PCB:

1. Star ground at bulk capacitor C13: all primary grounds should be connected to the ground of bulk capacitor C13 separately at a single point. It can reduce the switching noise going into the sensitive pins of the CoolSET™ device effectively. The primary star ground can be split into four groups as follows,
  - i. Combine signal (all small signal grounds connecting to the CoolSET™ GND pin such as filter capacitor ground C17, C18, C19 and optocoupler ground) and power ground (current sense resistors R14 and R14A).
  - ii. VCC ground includes the VCC capacitor ground C16 and the auxiliary winding ground, pin three of the power transformer.
  - iii. EMI return ground includes Y capacitor C12.
  - iv. DC ground from bridge rectifier, BR1
2. Filter capacitor close to the controller ground: filter capacitors, C17, C18 and C19 should be placed as close to the controller ground and the controller pin as possible so as to reduce the switching noise coupled into the controller.
3. High voltage traces clearance: High voltage traces should maintain sufficient spacing to nearby traces to avoid arcing.
  - i. 400 V traces (positive rail of bulk capacitor C13) to nearby trace: > 2.0 mm
  - ii. 600 V traces (drain voltage of CoolSET™ IC11) to nearby trace: > 2.5 mm
4. Recommended minimum of 232mm<sup>2</sup> copper areas at the drain pin to add on PCB for better thermal performance.
5. Power loop area (bulk capacitor C13, primary winding of the transformer TR1 (Pin seven and five), IC11 drain pin, IC11 CS pin and current sense resistor R14/R14A) should be as small as possible to minimize the switching emissions.

PCB layout

7 PCB layout

7.1 Top side

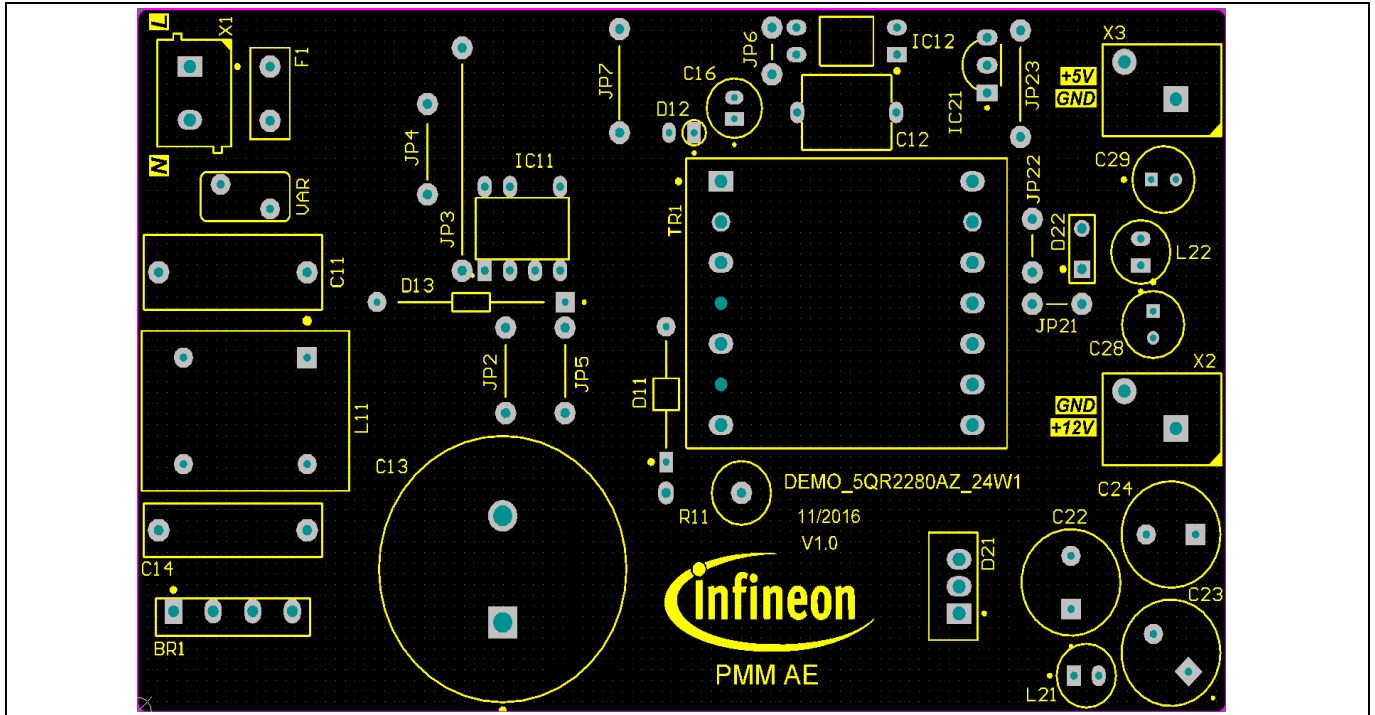

Figure 3 Top side component legend

7.2 Bottom side

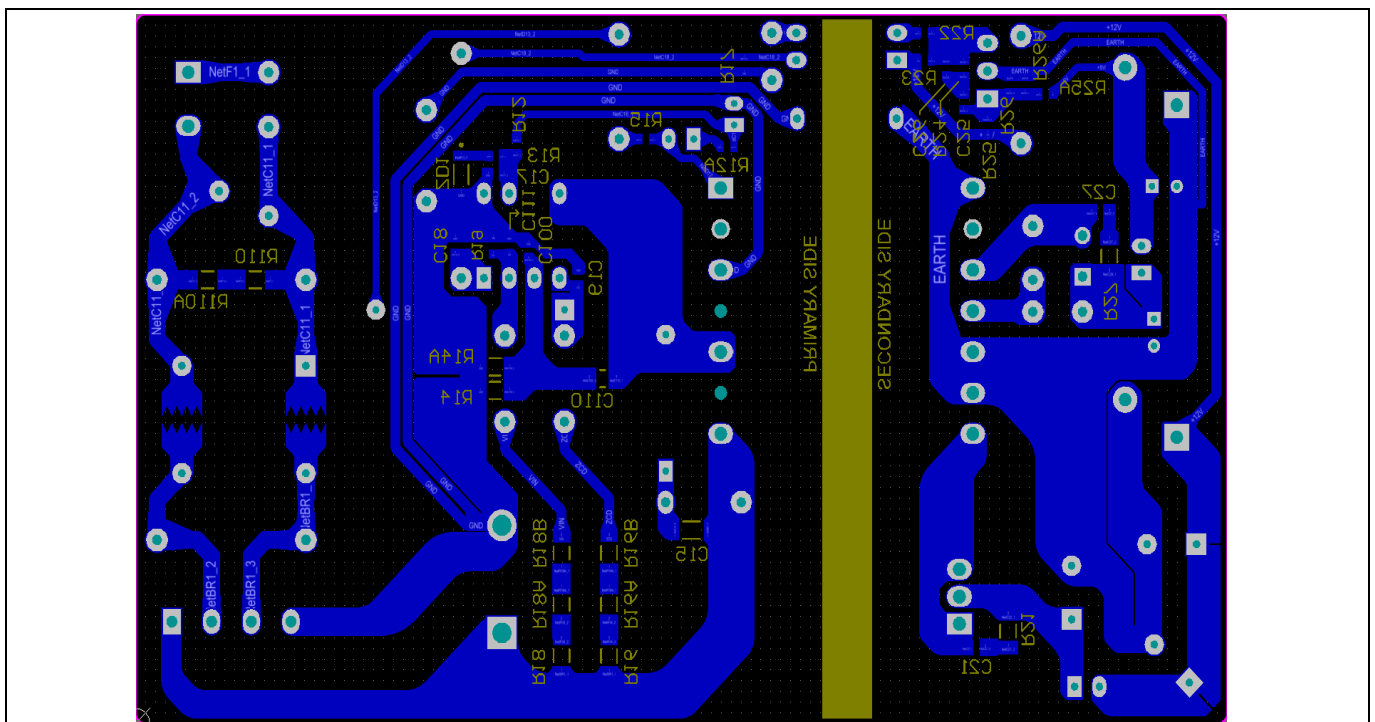

Figure 4 Bottom side copper and component legend

## BOM

## 8 BOM

Table 3 BOM (V0.7)

| No. | Designator      | Description                        | Part Number        | Manufacturer      | Quantity |
|-----|-----------------|------------------------------------|--------------------|-------------------|----------|
| 1   | BR1             | 600 V/1 A                          | S1VBA60            | Shindengen        | 1        |
| 2   | C11             | 0.22 $\mu$ F/305 V                 | B32922C3224        | Epcos             | 1        |
| 3   | C12             | 2.2 nF/500 V                       | DE1E3RA222MA4BQ    | Murata            | 1        |
| 4   | C13             | 68 $\mu$ F/500 V                   | LGN2H680MELA25     | Nichicon          | 1        |
| 5   | C14             | 0.1 $\mu$ F/305 V                  | B329221C3104K      | Epcos             | 1        |
| 6   | C15             | 1 nF/1000 V                        | GRM31BR73A102KW01# | Murata            | 1        |
| 7   | C16             | 22 $\mu$ F/50 V                    | 50PX22MEFC5X11     | Rubycon           | 1        |
| 8   | C17             | 100 nF/50 V                        | GRM188R71H104KA93D | Murata            | 1        |
| 9   | C18, C26, C111  | 1 nF/50 V                          | GRM1885C1H102GA01D | Murata            | 3        |
| 10  | C19             | 100 pF/50 V                        | GRM1885C1H101GA01D | Murata            | 1        |
| 11  | C22, C23, C24   | 1000 $\mu$ F/16 V                  | 16ZLH1000MEFC10X16 | Rubycon           | 3        |
| 12  | C25             | 220 nF/50 V                        | GRM188R71H224KAC4D | Murata            | 1        |
| 13  | C28, C29        | 330 $\mu$ F/10 V                   | 10ZLH330MEFC6.3X11 | Rubycon           | 2        |
| 14  | C100            | 22 nF/25 V                         | GRM188B11E223KA01D | Murata            | 1        |
| 15  | D11             | 1 A/800 V                          | UF4006             |                   | 1        |
| 16  | D12             | 0.2 A/200 V                        | 1N485B             |                   | 1        |
| 17  | D13             | 0.2 A/150 V/50 ns                  | FDH400             |                   | 1        |
| 18  | D21             | 10 A/100 V                         | MBRF10100CT        | Vishay            | 1        |
| 19  | D22             | 1 A/45 V                           | SB150              | Vishay            | 1        |
| 20  | F1              | 1.6 A/300 V                        | 36911600000        | Littlefuse        | 1        |
| 21  | HS21            | Heatsink                           | 577202B00000G      | AAVID             | 1        |
| 22  | IC11            | ICE5QR2280AZ                       | ICE5QR2280AZ       | Infineon          | 1        |
| 23  | IC12            | Optocoupler                        | SFH617A-3          |                   | 1        |
| 24  | IC21            | Shunt regulator                    | TL431BVLPG         |                   | 1        |
| 25  | L11             | 27 mH/0.7 A                        | B82731M2701A030    | Epcos             | 1        |
| 26  | L21             | 2.2 $\mu$ H/4.3 A                  | 744 746 202 2      | Würth Electronics | 1        |
| 27  | L22             | 4.7 $\mu$ H/4.2 A                  | 744 746 204 7      | Würth Electronics | 1        |
| 28  | R11             | 68 k $\Omega$ /2 W/500 V           | MO2CT631R683J      | KOA Speer         | 1        |
| 29  | R12, R13        | 0 $\Omega$ (0603)                  |                    |                   | 2        |
| 30  | R12A            | 4.7 $\Omega$ (0603)                |                    |                   | 1        |
| 31  | R14             | 1.2 $\Omega$ / 0.25 W/<br>$\pm$ 1% | ERJ8RQF1R2V        | Panasonic         | 1        |
| 32  | R14A            | 1.3 $\Omega$ / 0.33 W/<br>$\pm$ 1% | ERJ8BQF1R3V        | Panasonic         | 1        |
| 33  | R15             | 30 k $\Omega$ $\pm$ 1% (0603)      |                    |                   | 1        |
| 34  | R16, R16A, R16B | 15 m $\Omega$ /0.25 W/5%           | RC1206JR-0715ML    |                   | 3        |
| 35  | R18, R18A, R18B | 3 m $\Omega$ /0.25 W/1%            | RC1206FR-073ML     |                   | 3        |
| 36  | R19             | 58.3 k $\Omega$ /0.1<br>W/0.5%     | RT0603DRE0758K3L   |                   | 1        |
| 37  | R110, R110A     | 1.5 m $\Omega$ /5%/200 V           | RC1206FR-071M5L    |                   | 2        |
| 38  | R22             | 820 $\Omega$ (0603)                |                    |                   | 1        |
| 39  | R23             | 1.2 k $\Omega$ (0603)              |                    |                   | 1        |
| 40  | R24             | 68 k $\Omega$ (0603)               |                    |                   | 1        |

**BOM**

|    |                             |                       |                    |                   |   |
|----|-----------------------------|-----------------------|--------------------|-------------------|---|
| 41 | R25                         | 110 k $\Omega$ (0603) |                    |                   | 1 |
| 42 | R25A                        | 15 k $\Omega$ (0603)  |                    |                   | 1 |
| 43 | R26                         | 10 k $\Omega$ (0603)  |                    |                   | 1 |
| 44 | TR1                         | 400 $\mu$ H           | 750343101(Rev 0.2) | Würth Electronics | 1 |
| 45 | VAR                         | 0.25 W/320 V          | B72207S2321K101    | Epcos             | 1 |
| 46 | ZD1                         | 22 V Zener            |                    |                   | 1 |
| 47 | X1(L N)                     | Connector             | 691102710002       | Würth Electronics | 1 |
| 48 | X2(+12 V Com), X3(+5 V Com) | Connector             | 691 412 120 002B   | Würth Electronics | 2 |

Transformer construction

## 9 Transformer construction

Core and material: EE25/13/7(EF25), TP4A (TDG)

Bobbin: 070-5644 (14 pin, THT, horizontal version)

Primary inductance:  $L_p=400 \mu\text{H}$  ( $\pm 10\%$ ), measured between pin five and pin seven

Manufacturer and part number: Wurth Electronics Midcom (750343101)

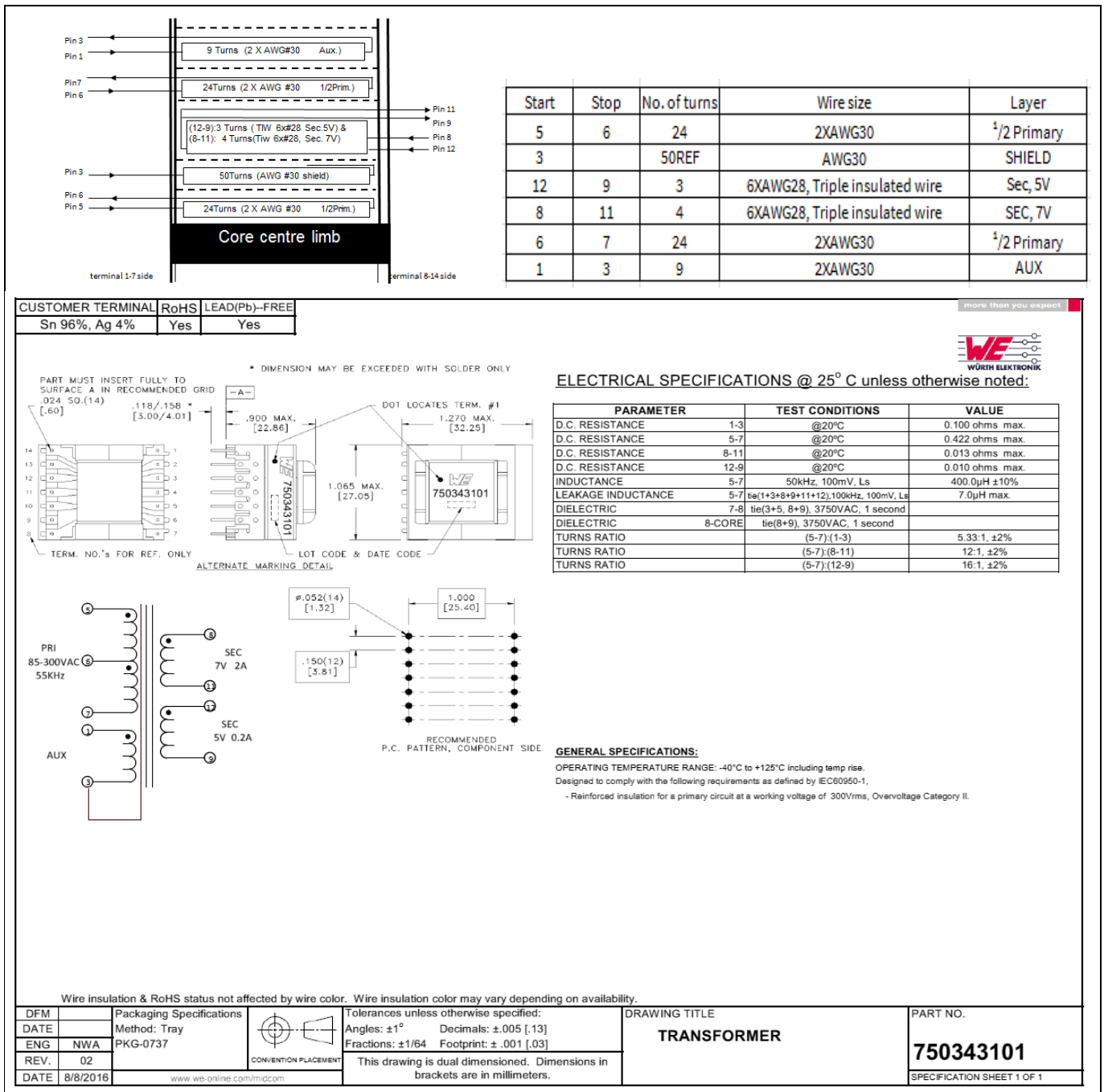

Figure 5 Transformer structure

Test results

# 10 Test results

## 10.1 Efficiency, regulation and output ripple

**Table 4 Efficiency, regulation & output ripple**

| Input (V AC/Hz) | P <sub>in</sub> (W) | V <sub>out1</sub> (V DC) | I <sub>out1</sub> (A) | V <sub>out2</sub> (V DC) | I <sub>out2</sub> (A) | V <sub>outRPP1</sub> (mV) | V <sub>outRPP2</sub> (mV) | P <sub>out</sub> (W) | Efficiency η (%) | Average η (%) | OLP P <sub>in</sub> (W) | OLP I <sub>out12V</sub> (Fixed 5 V at 0.2 A) (A) |
|-----------------|---------------------|--------------------------|-----------------------|--------------------------|-----------------------|---------------------------|---------------------------|----------------------|------------------|---------------|-------------------------|--|
| 85 V AC/ 60 Hz  | 0.0360              | 11.90                    | 0.000                 | 4.93                     | 0.0000                | 51                        | 18                        | /                    | /                | /             | 39.50                   | 2.55   |
|                 | 0.080               | 12.85                    | 0.0000                | 4.80                     | 0.0060                | 33                        | 64                        | 0.03                 |                  |               |                         |  |
|                 | 14.52               | 11.83                    | 1.000                 | 4.94                     | 0.0600                | 84                        | 11                        | 12.13                | 83.52            |               |                         |  |
|                 | 7.390               | 11.90                    | 0.5000                | 4.93                     | 0.0500                | 64                        | 11                        | 6.20                 | 83.85            | 83.18         |                         |  |
|                 | 14.81               | 11.90                    | 1.000                 | 4.93                     | 0.1000                | 85                        | 12                        | 12.39                | 83.68            |               |                         |  |
|                 | 22.25               | 11.89                    | 1.500                 | 4.93                     | 0.1500                | 90                        | 13                        | 18.58                | 83.48            |               |                         |  |
| 29.17           | 11.90               | 1.920                    | 4.93                  | 0.2000                   | 116                   | 17                        | 23.83                     | 81.71                |                  |               |                         |  |
| 115 V AC/ 60 Hz | 0.0420              | 11.91                    | 0.000                 | 4.93                     | 0.0000                | 51                        | 18                        | /                    | /                | /             | 43.50                   | 2.99   |
|                 | 0.086               | 12.93                    | 0.0000                | 4.79                     | 0.0060                | 35                        | 68                        | 0.03                 |                  |               |                         |  |
|                 | 14.29               | 11.84                    | 1.000                 | 4.94                     | 0.0600                | 78                        | 12                        | 12.14                | 84.93            |               |                         |  |
|                 | 7.37                | 11.91                    | 0.5000                | 4.93                     | 0.0500                | 63                        | 11                        | 6.20                 | 84.15            | 84.64         |                         |  |
|                 | 14.61               | 11.91                    | 1.000                 | 4.93                     | 0.1000                | 78                        | 12                        | 12.40                | 84.90            |               |                         |  |
|                 | 21.94               | 11.91                    | 1.500                 | 4.93                     | 0.1500                | 88                        | 13                        | 18.60                | 84.80            |               |                         |  |
| 28.14           | 11.90               | 1.920                    | 4.93                  | 0.2000                   | 99                    | 13                        | 23.83                     | 84.70                |                  |               |                         |  |
| 230 V AC/ 50 Hz | 0.0780              | 11.91                    | 0.000                 | 4.93                     | 0.0000                | 56                        | 18                        | /                    | /                | /             | 44.00                   | 3.03   |
|                 | 0.124               | 12.99                    | 0.0000                | 4.79                     | 0.0060                | 35                        | 73                        | 0.03                 |                  |               |                         |  |
|                 | 14.50               | 11.84                    | 1.000                 | 4.94                     | 0.0600                | 86                        | 12                        | 12.14                | 83.70            |               |                         |  |
|                 | 7.62                | 11.91                    | 0.5000                | 4.93                     | 0.0500                | 68                        | 11                        | 6.20                 | 81.39            | 83.65         |                         |  |
|                 | 14.81               | 11.91                    | 1.000                 | 4.93                     | 0.1000                | 87                        | 12                        | 12.40                | 83.75            |               |                         |  |
|                 | 22.01               | 11.91                    | 1.500                 | 4.93                     | 0.1500                | 90                        | 13                        | 18.60                | 84.53            |               |                         |  |
| 28.09           | 11.91               | 1.920                    | 4.93                  | 0.2000                   | 110                   | 14                        | 23.85                     | 84.92                |                  |               |                         |  |
| 265 V AC/ 50 Hz | 0.094               | 11.90                    | 0.000                 | 4.93                     | 0.0000                | 55                        | 19                        | /                    | /                | /             | 45.50                   | 3.15   |
|                 | 0.141               | 13.00                    | 0.0000                | 4.78                     | 0.0060                | 35                        | 77                        | 0.03                 |                  |               |                         |  |
|                 | 14.71               | 11.84                    | 1.000                 | 4.94                     | 0.0600                | 86                        | 13                        | 12.14                | 82.50            |               |                         |  |
|                 | 7.78                | 11.91                    | 0.5000                | 4.93                     | 0.0500                | 68                        | 11                        | 6.20                 | 79.71            | 82.57         |                         |  |
|                 | 14.99               | 11.91                    | 1.000                 | 4.93                     | 0.1000                | 86                        | 13                        | 12.40                | 82.74            |               |                         |  |
|                 | 22.28               | 11.91                    | 1.500                 | 4.93                     | 0.1500                | 90                        | 13                        | 18.60                | 83.50            |               |                         |  |
| 28.29           | 11.91               | 1.920                    | 4.93                  | 0.2000                   | 108                   | 14                        | 23.85                     | 84.32                |                  |               |                         |  |
| 300 V AC/ 50 Hz | 0.115               | 11.91                    | 0.000                 | 4.93                     | 0.0000                | 57                        | 20                        | /                    | /                | /             | 46.00                   | 3.22   |
|                 | 0.166               | 13.01                    | 0.0000                | 4.78                     | 0.0060                | 37                        | 85                        | 0.03                 |                  |               |                         |  |
|                 | 14.90               | 11.84                    | 1.000                 | 4.94                     | 0.0600                | 85                        | 12                        | 12.14                | 81.45            |               |                         |  |
|                 | 7.94                | 11.91                    | 0.5000                | 4.93                     | 0.0500                | 68                        | 11                        | 6.20                 | 78.11            | 81.42         |                         |  |
|                 | 15.20               | 11.91                    | 1.000                 | 4.93                     | 0.1000                | 85                        | 12                        | 12.40                | 81.60            |               |                         |  |
|                 | 22.56               | 11.91                    | 1.500                 | 4.93                     | 0.1500                | 87                        | 13                        | 18.60                | 82.47            |               |                         |  |
| 28.57           | 11.91               | 1.920                    | 4.93                  | 0.2000                   | 108                   | 14                        | 23.85                     | 83.49                |                  |               |                         |  |

Minimum load condition : 5 V @ 6 mA  
 Typical load condition : 5 V @ 60 mA and 12 V @ 1 A  
 Maximum load condition : 5 V @ 200 mA and 12 V @ 1.92 A

Test results

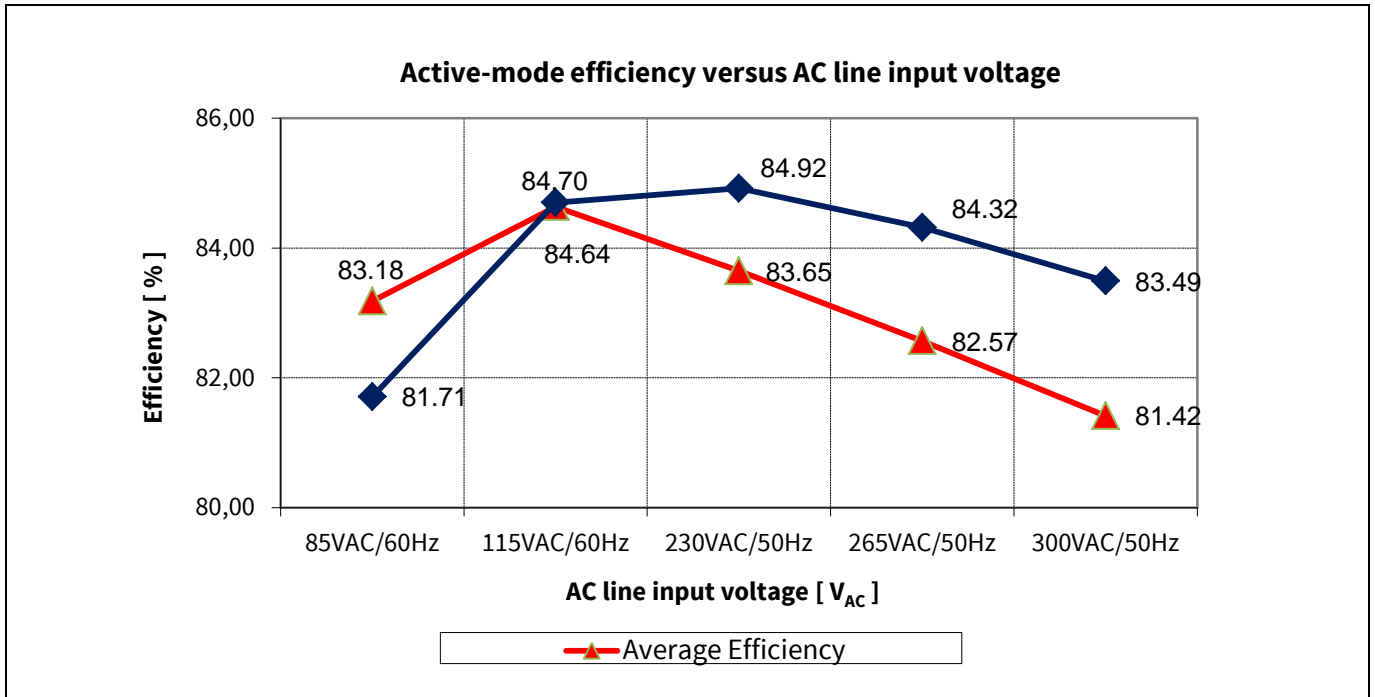

Figure 6 Efficiency vs AC line input voltage

10.2 Standby power

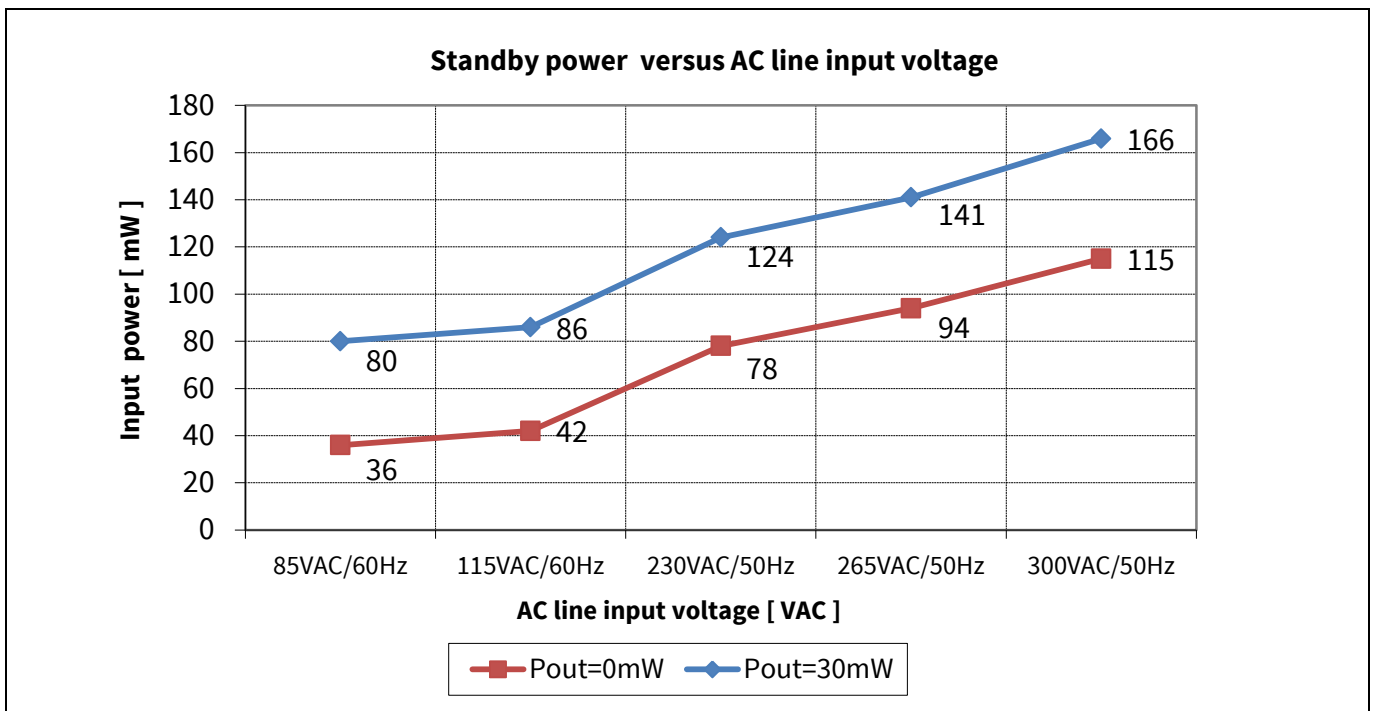

Figure 7 Standby power at no load and 30 mW load vs AC line input voltage (measured by Yokogawa WT210 power meter - integration mode)

Test results

10.3 Line regulation

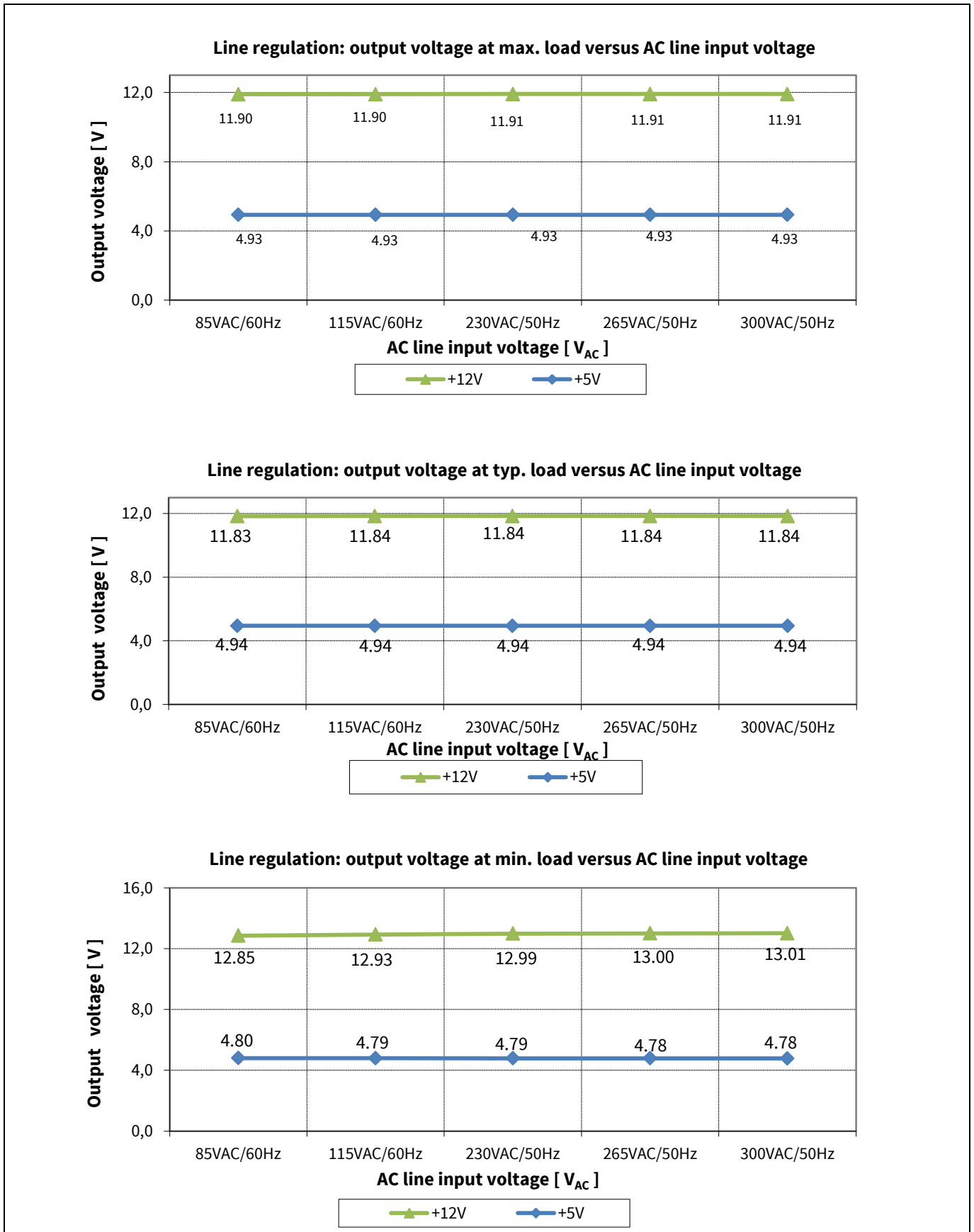

Figure 8 Line regulation V<sub>out</sub> at full load vs AC line input voltage



Test results

10.4 Load regulation

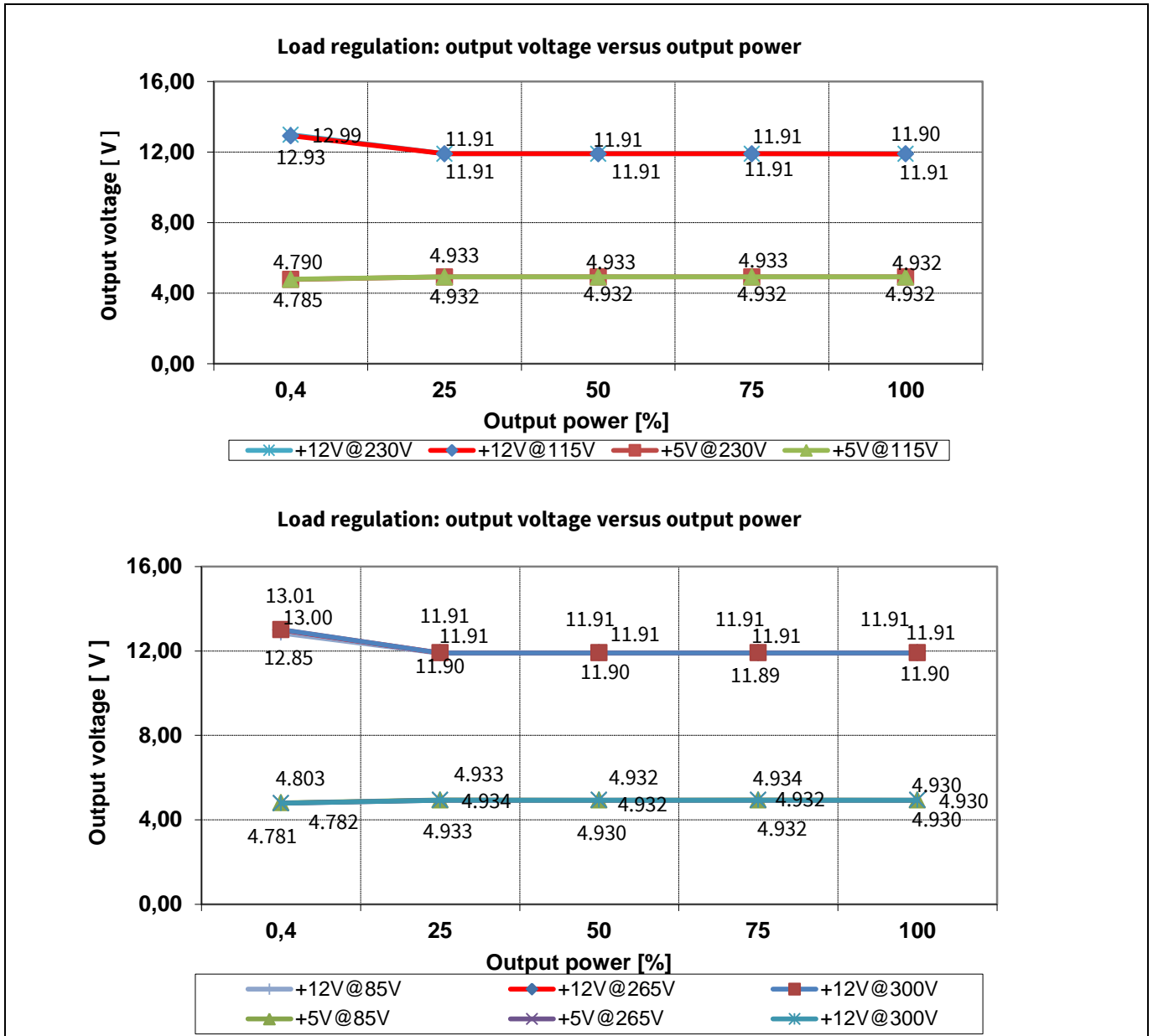

Figure 9 Load regulation  $V_{out}$  vs output power

Test results

10.5 Maximum input power

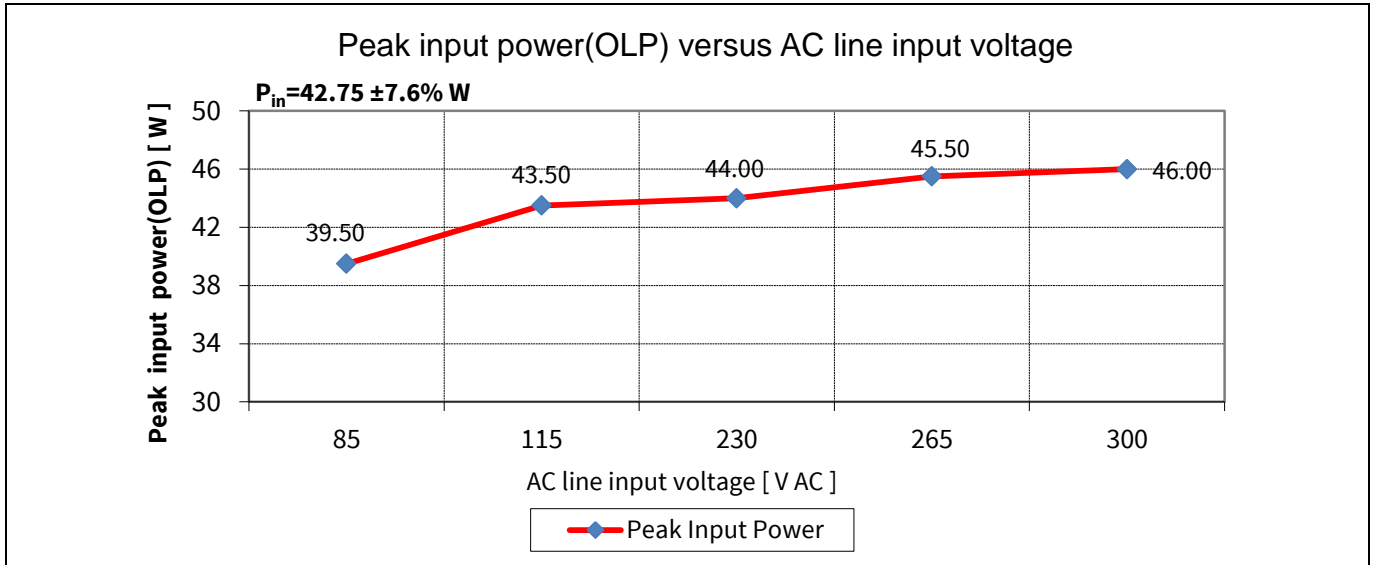

Figure 10 Maximum input power (before overload protection) vs AC line input voltage

10.6 ESD immunity (EN61000-4-2)

Pass EN61000-4-2 special level ( $\pm 14$  kV for contact discharge and  $\pm 16$  kV air discharge).

10.7 Surge immunity (EN61000-4-5)

Pass EN61000-4-5 installation class 4 ( $\pm 2$  kV for line to line and  $\pm 4$  kV for line to earth)<sup>1</sup>.

10.8 Conducted emissions (EN55022 class B)

The conducted EMI was measured using a Schaffner (SMR4503) in accordance with the test standard of EN55022 (CISPR 22) class B. The demo board was set up at maximum load (24 W) with an input voltage of 115 V AC and 230 V AC.

<sup>1</sup> PCB spark gap distance needs to reduce to 0.5 mm and C13 change to 120  $\mu$ F.

Test results

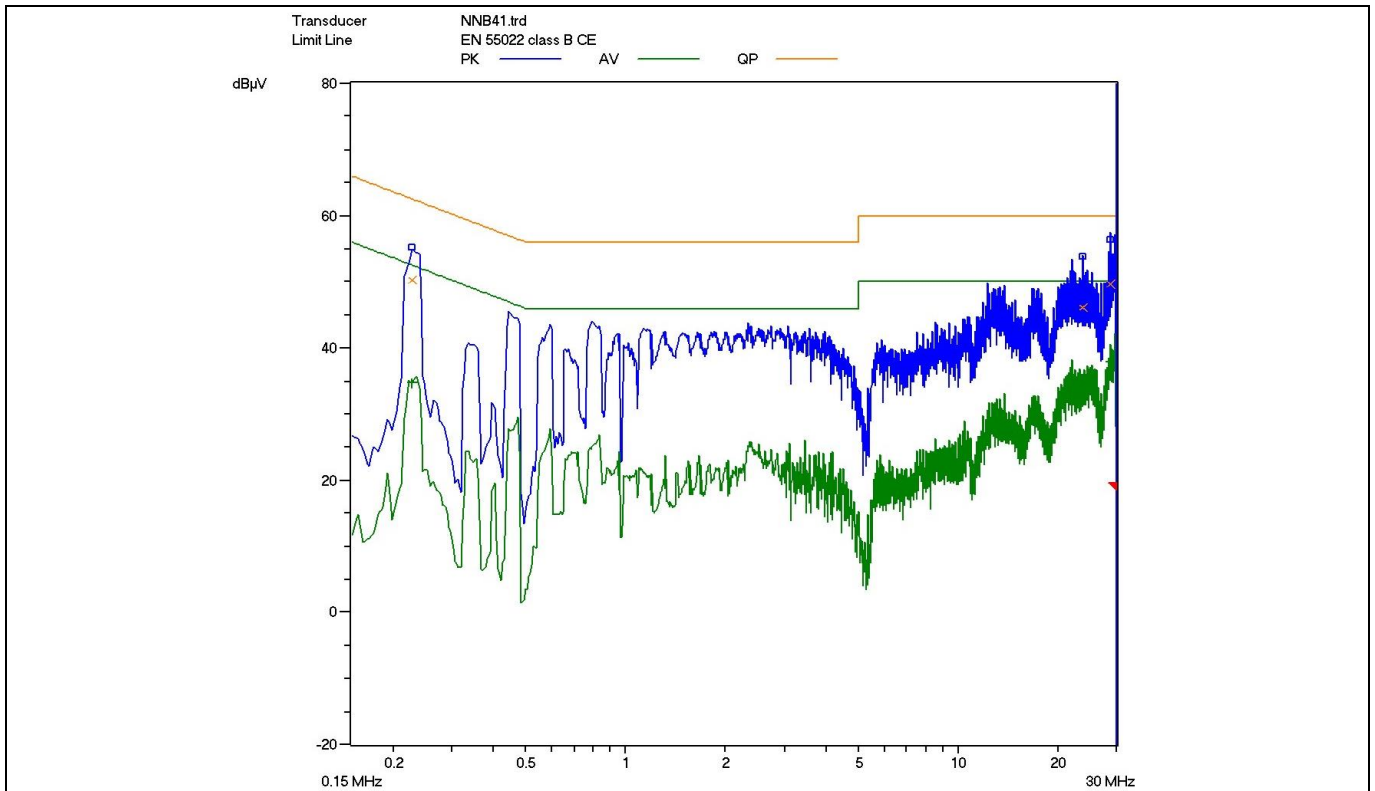

Figure 11 Conducted emissions (line) at 115 V AC and maximum load

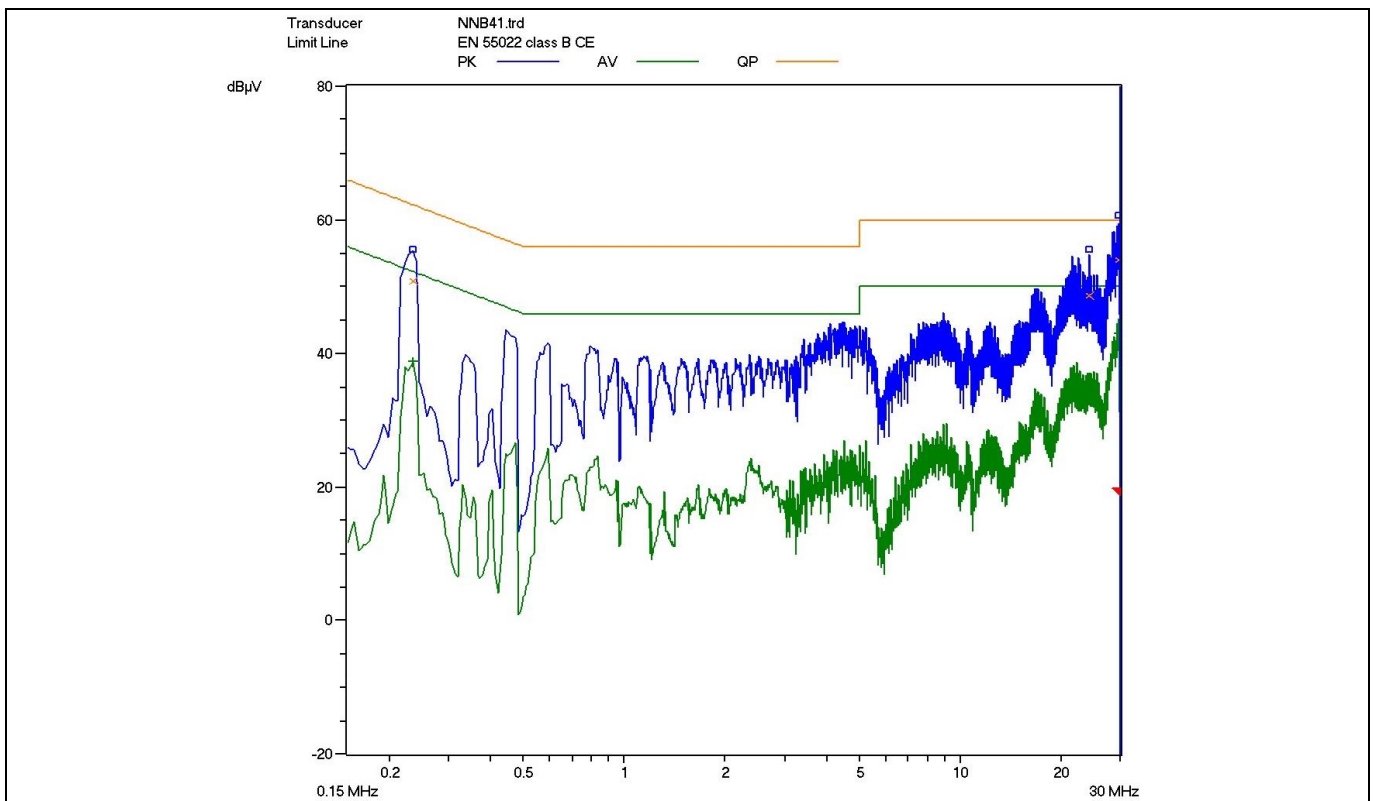

Figure 12 Conducted emissions (neutral) at 115 V AC and maximum load

Pass conducted emissions EN55022 (CISPR 22) class B with 7 dB margin for quasi peak measurement at low line (115 V AC).

Test results

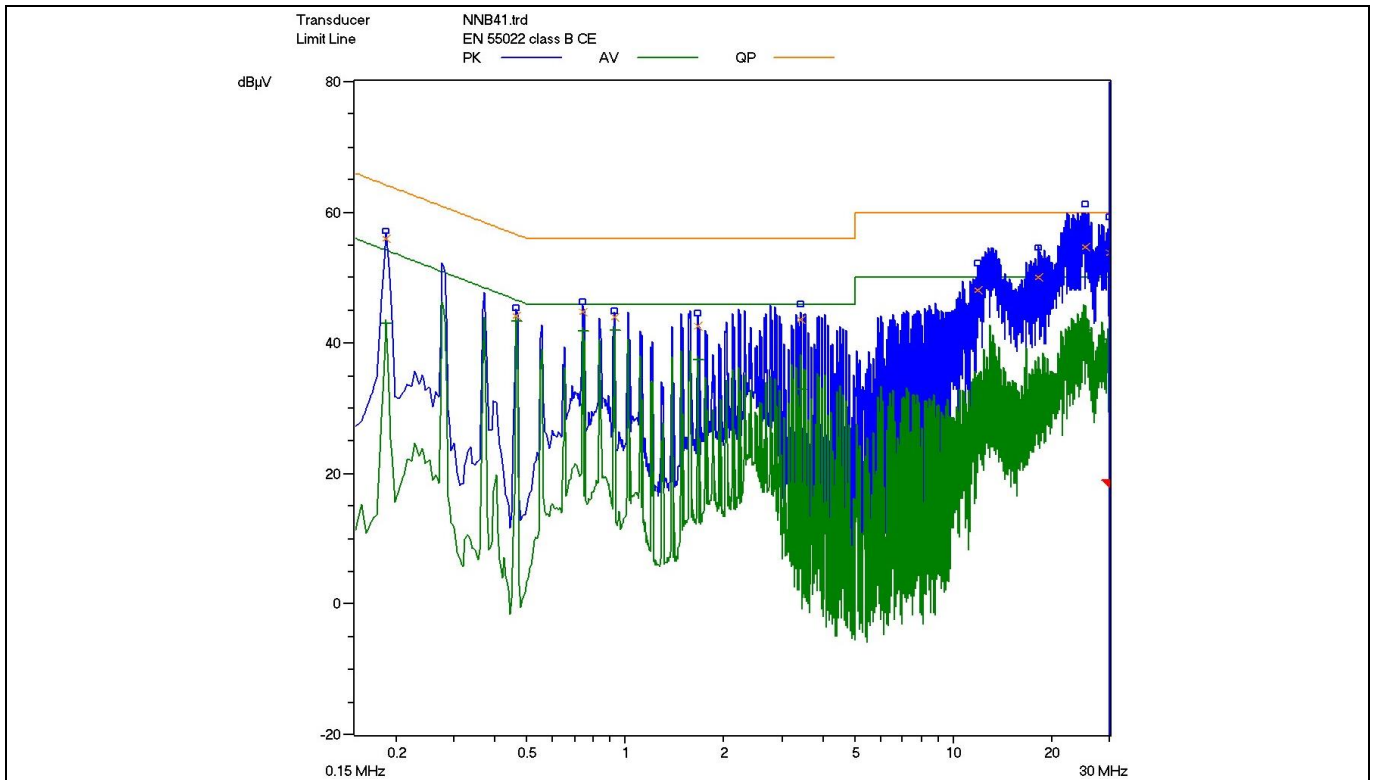

Figure 13 Conducted emissions (line) at 230 V AC and maximum load

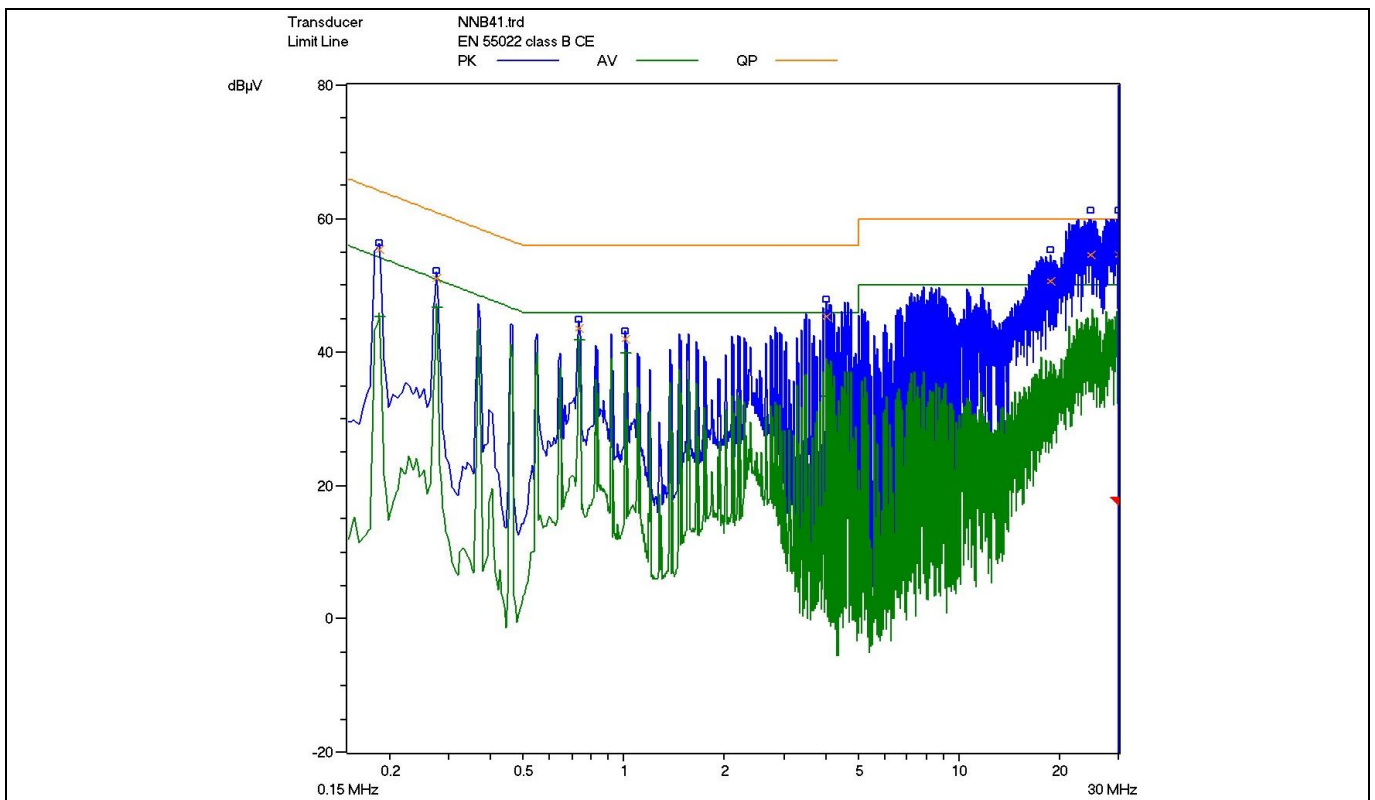

Figure 14 Conducted emissions (neutral) at 230 V AC and maximum load

Pass conducted emissions EN55022 (CISPR 22) class B with 6 dB margin for quasi peak measurement at high line (230 V AC).

Test results

10.9 Thermal measurement

The thermal test of the open frame demo board was performed using an infrared thermography camera (FLIR-T420) at an ambient temperature of 25°C. The measurements were taken after one hour running at full load.

Table 5 Hottest temperature of demo board

| No. | Major component       | 85 V AC (°C) | 300 V AC (°C) |
|-----|-----------------------|--------------|---------------|
| 1   | TR1 (transformer)     | 52.6         | 57.0          |
| 2   | D21 (Secondary diode) | 69.5         | 69.1          |
| 3   | BR1 (bridge diode)    | 58.4         | 40.0          |
| 4   | IC11 (ICE5QR2280AZ)   | 85.5         | 88.7          |
| 5   | L11 (choke)           | 72.0         | 46.2          |
| 6   | Ambient               | 25.0         | 25.0          |

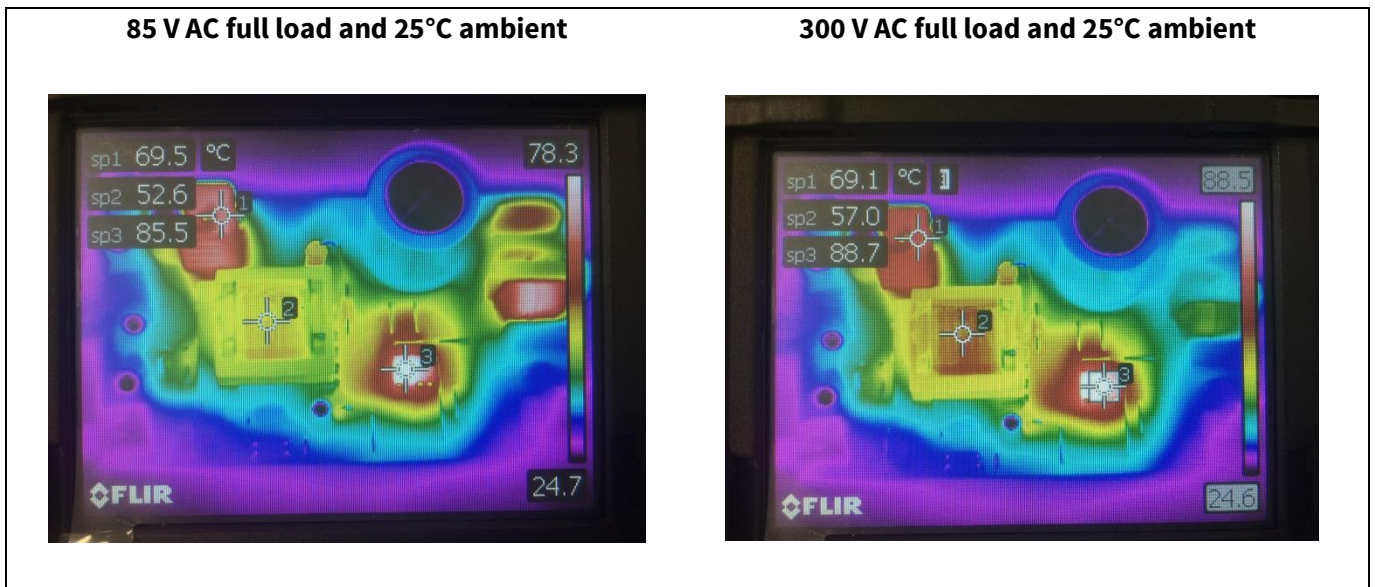

Figure 15 Infrared thermal image of DEMO\_5QR2280AZ\_24W1

Waveforms and oscilloscope plots

# 11 Waveforms and oscilloscope plots

All waveforms and scope plots were recorded with a TELEDYNE LECROY 606Zi oscilloscope.

## 11.1 Start-up at low/high AC line input voltage with maximum load

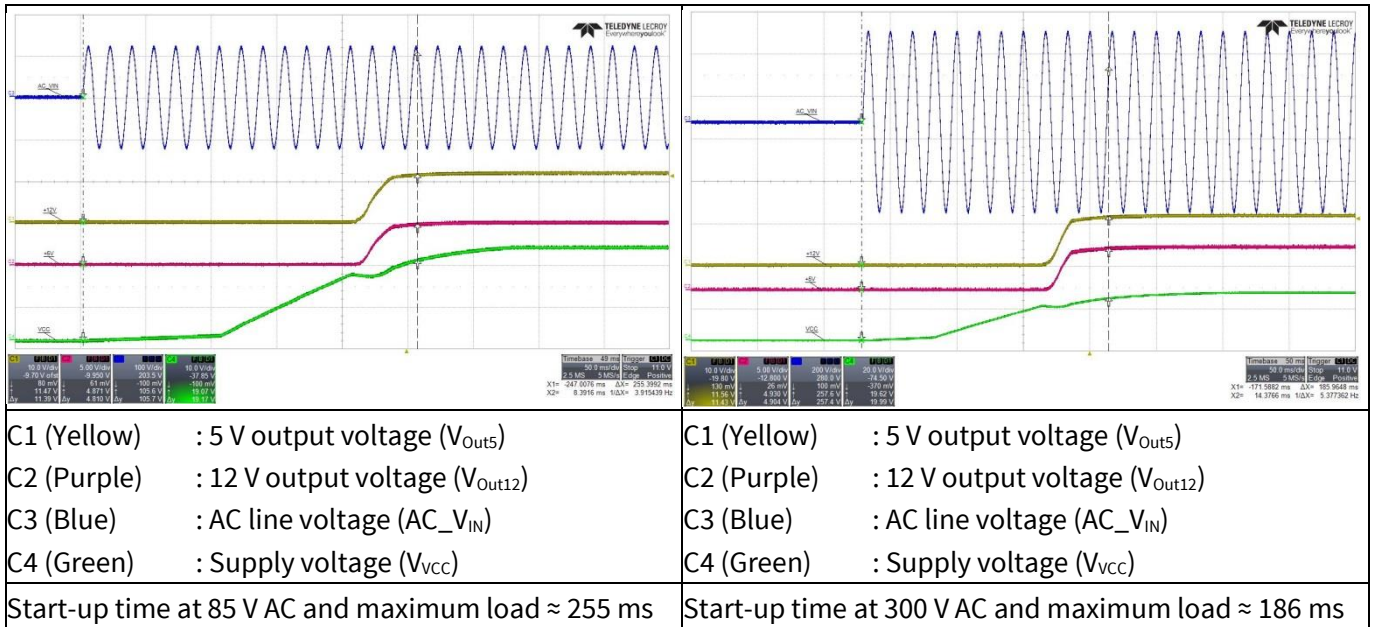

Figure 16 Start-up

## 11.2 Soft-start

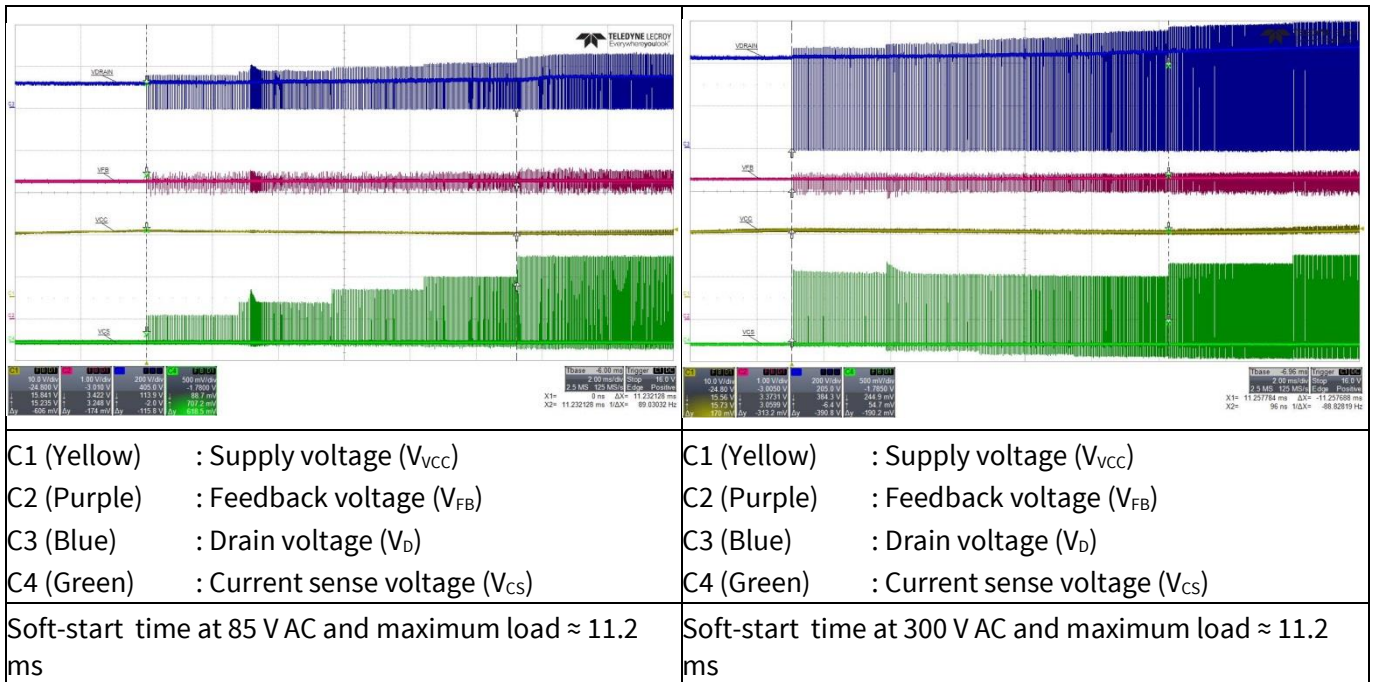

Figure 17 Soft-start



Waveforms and oscilloscope plots

11.3 Drain and current sense voltage at maximum load

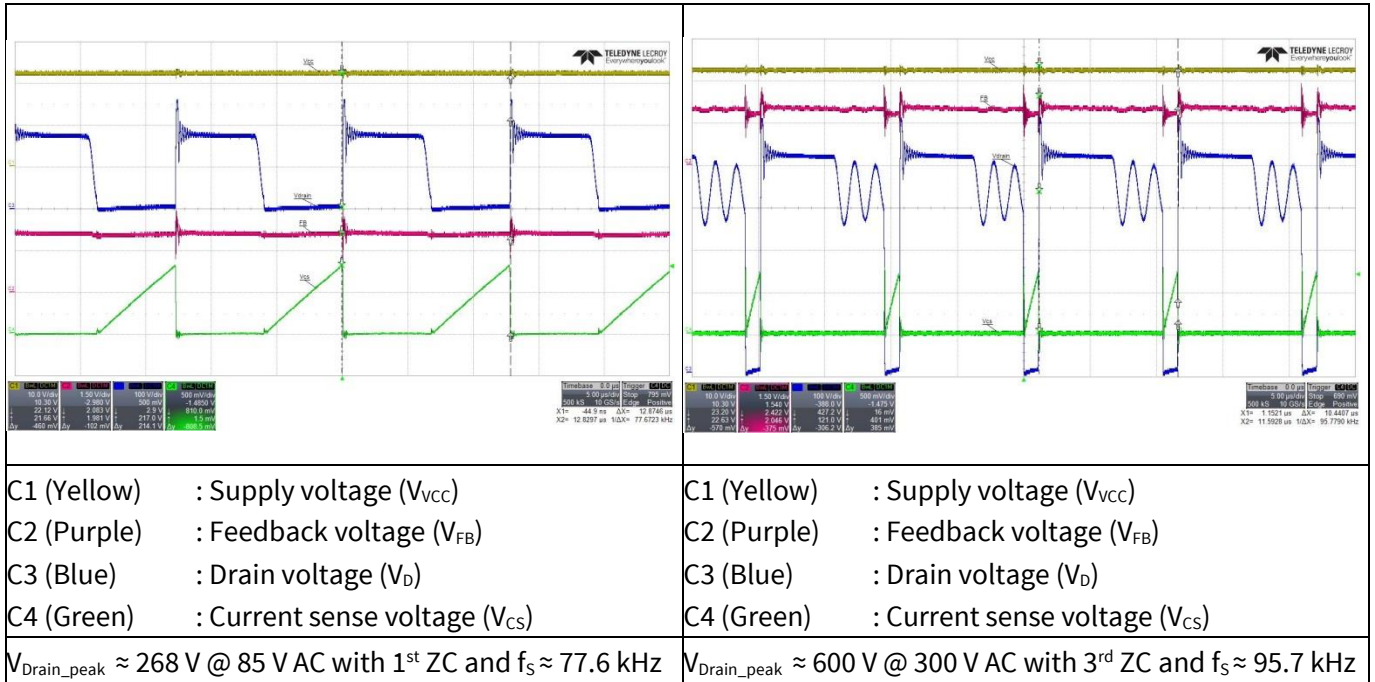

Figure 18 Drain and current sense voltage at maximum load

11.4 Zero crossing point during normal operation

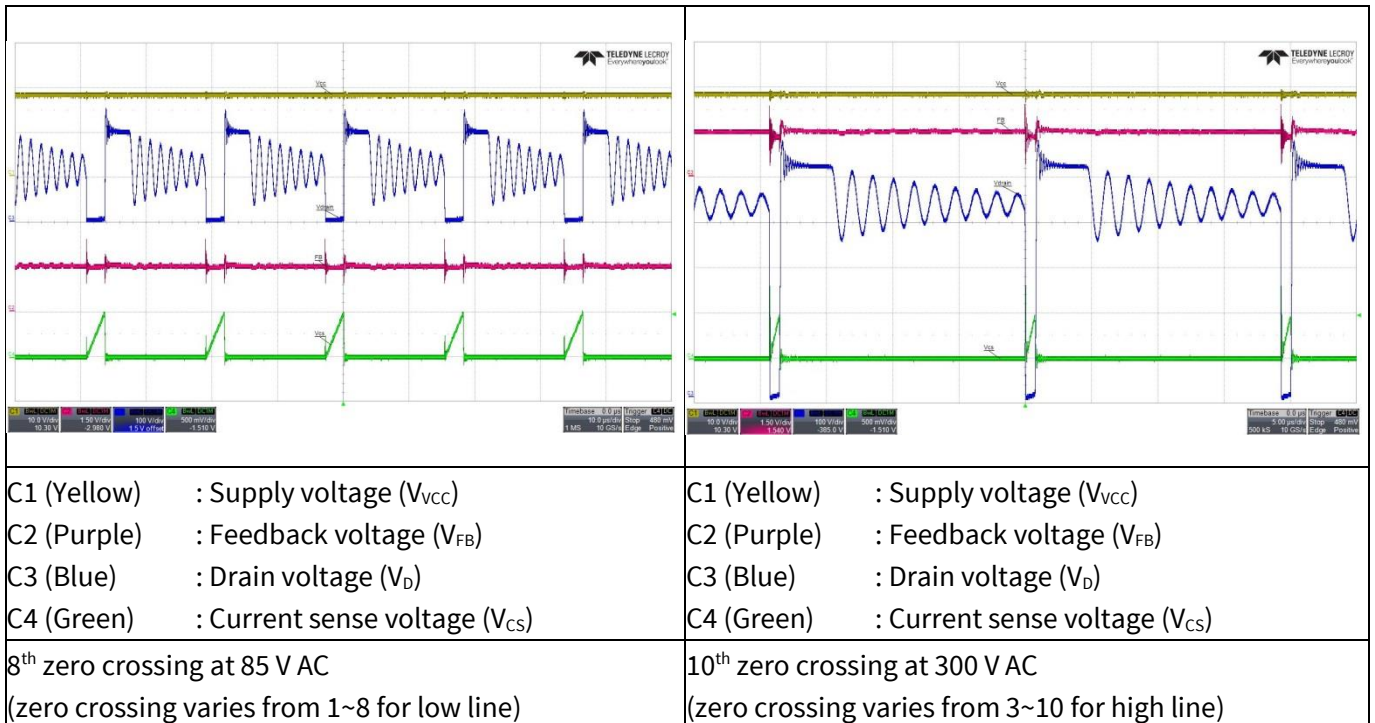

Figure 19 Zero crossing

Waveforms and oscilloscope plots

11.5 Load transient response (dynamic load from 10% to 100%)

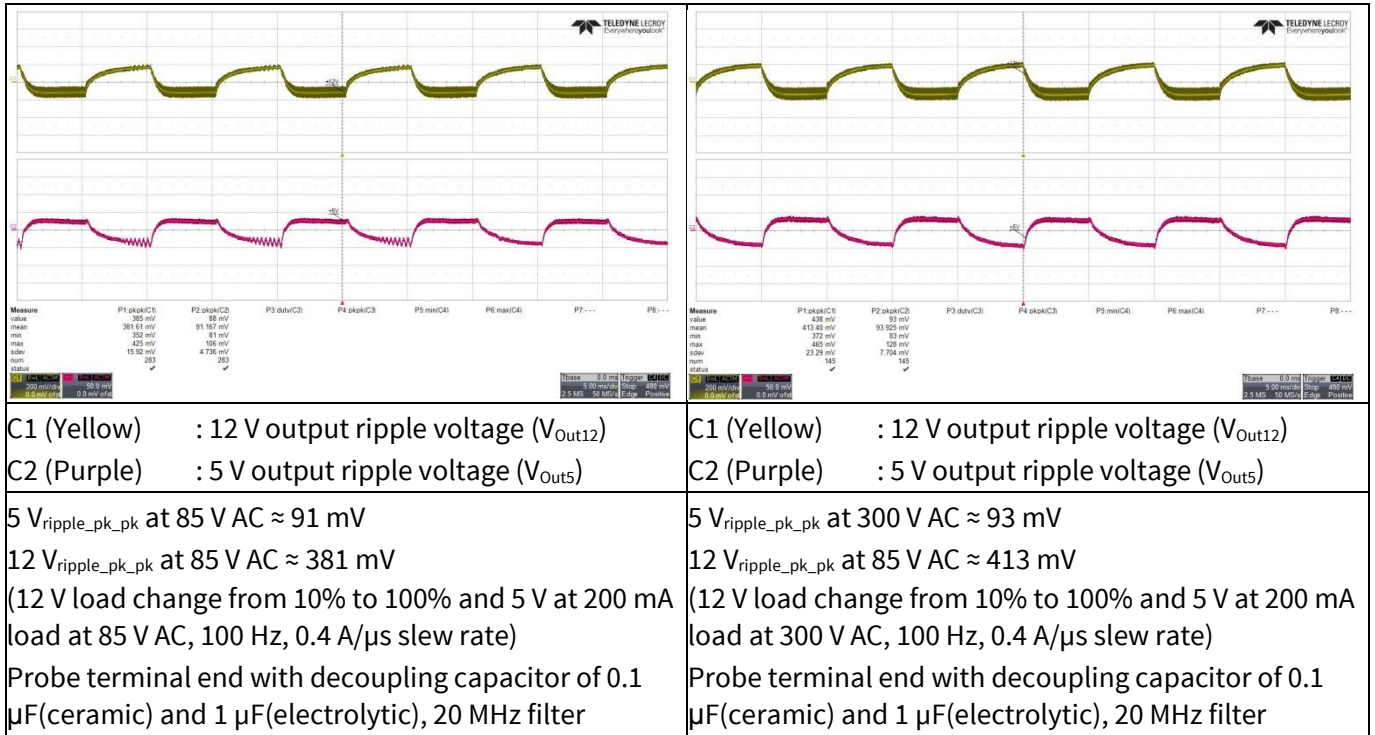

Figure 20 Load transient response

11.6 Output ripple voltage at maximum load

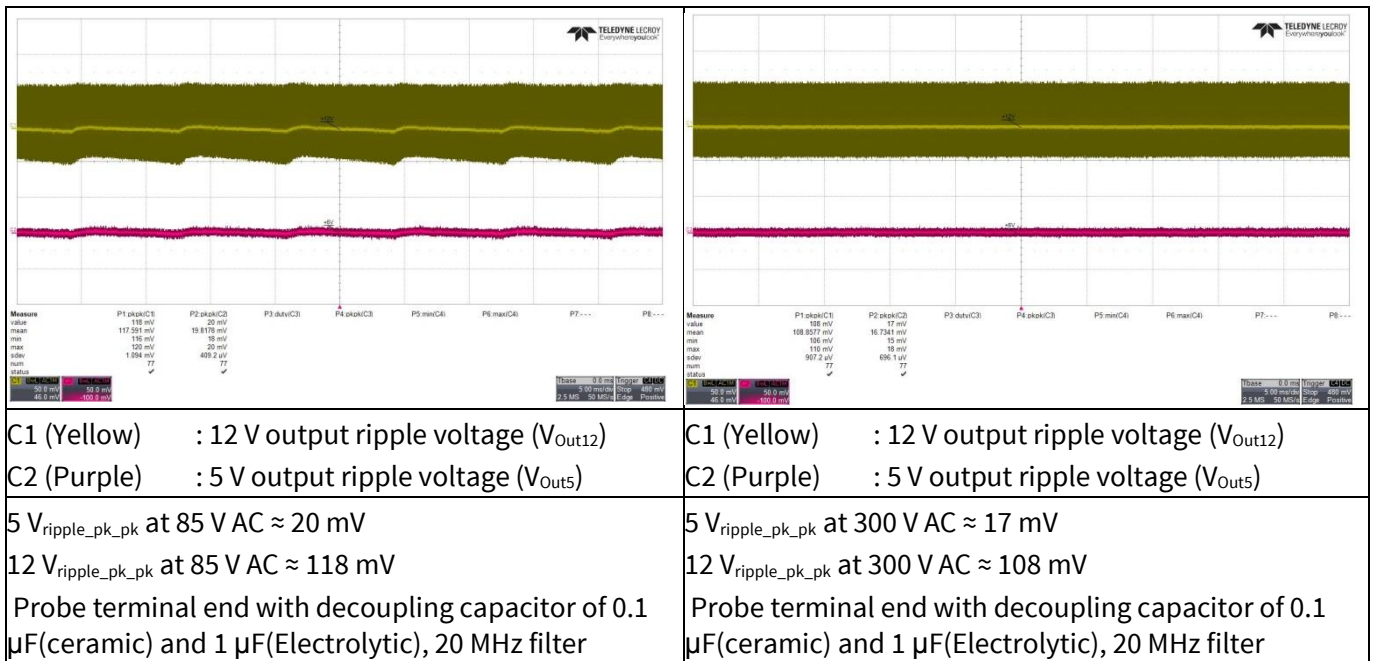

Figure 21 Output ripple voltage at maximum load



Waveforms and oscilloscope plots

11.7 Output ripple voltage at burst mode 1 W load

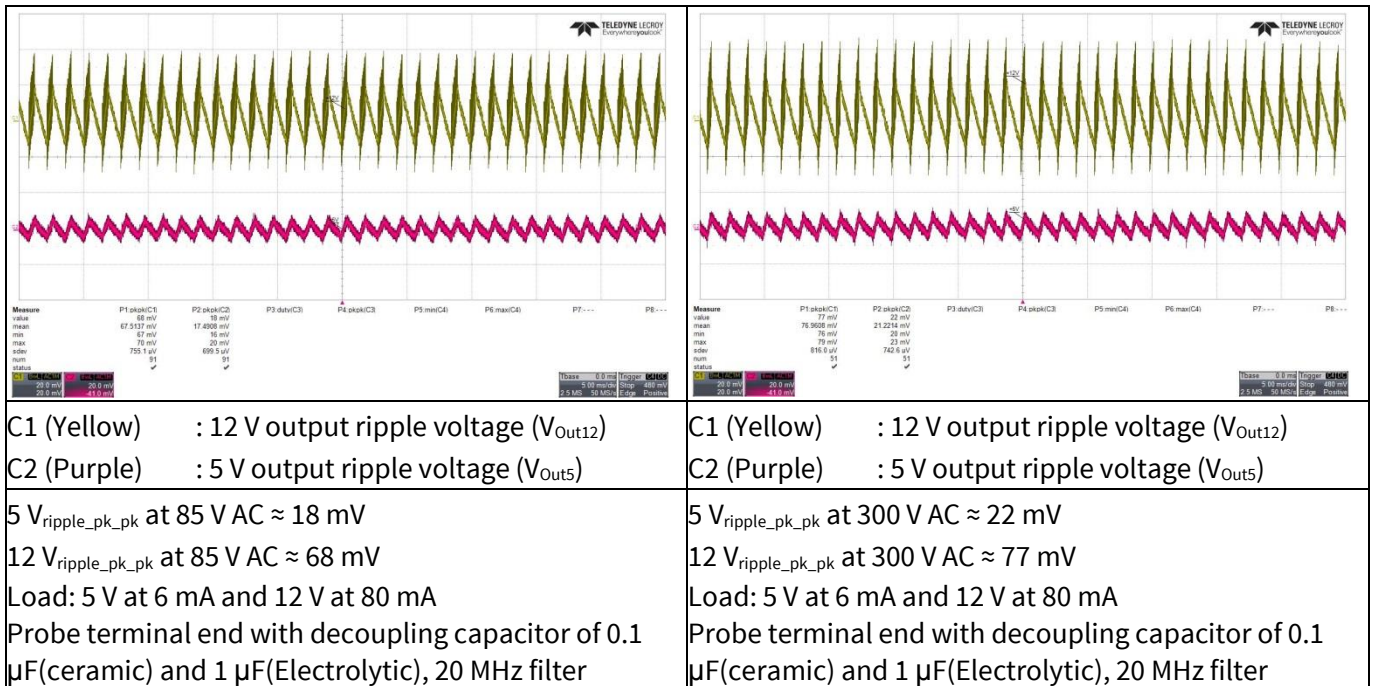

Figure 22 Output ripple voltage at burst mode 1 W load

11.8 Entering active burst mode

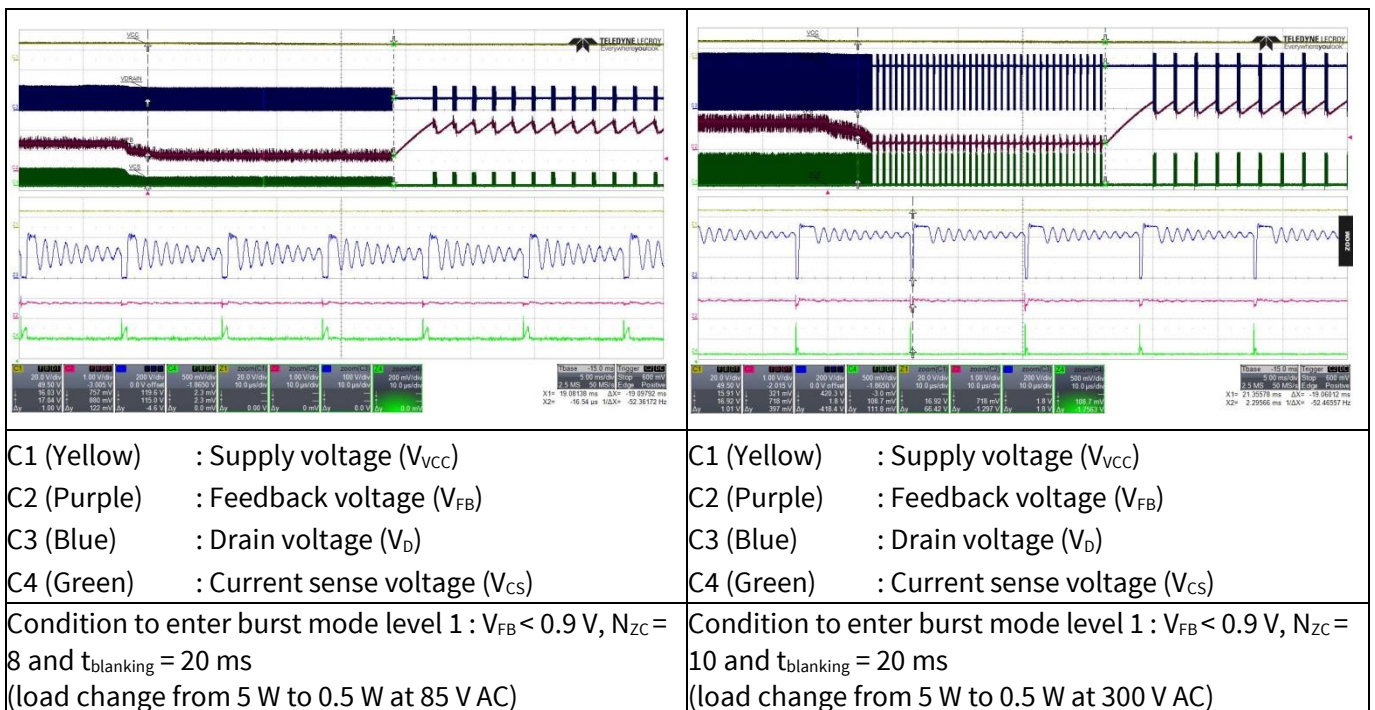

Figure 23 Entering active burst mode

Waveforms and oscilloscope plots

11.9 During active burst mode

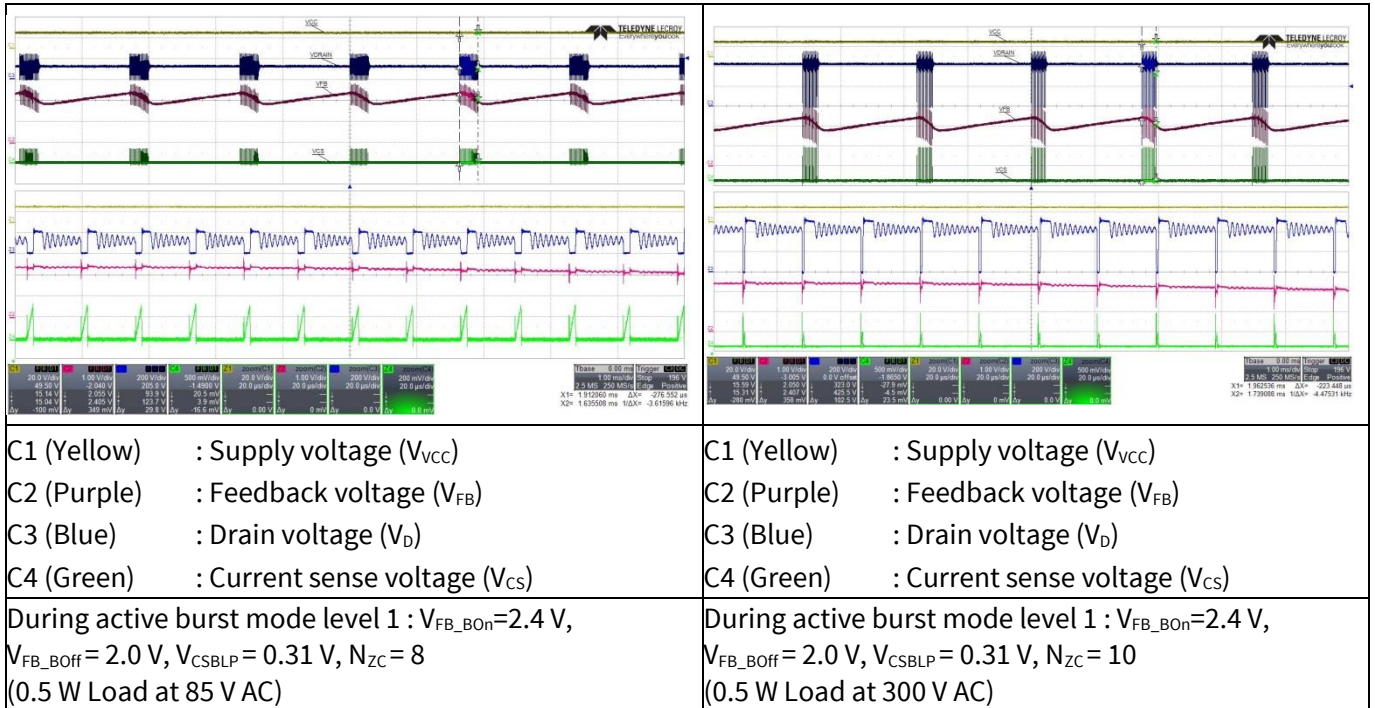

Figure 24 During active burst mode

11.10 Leaving active burst mode

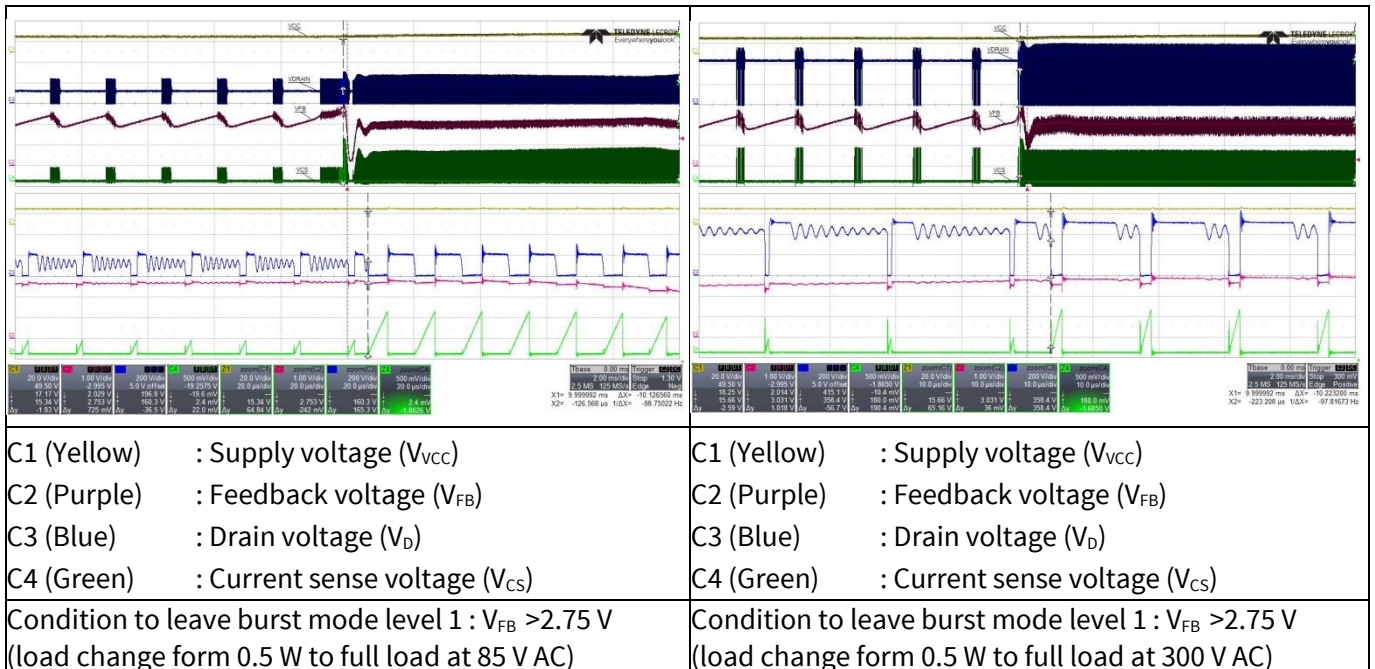

Figure 25 Leaving active burst mode

Waveforms and oscilloscope plots

11.11 Line over voltage protection (non switch auto restart)

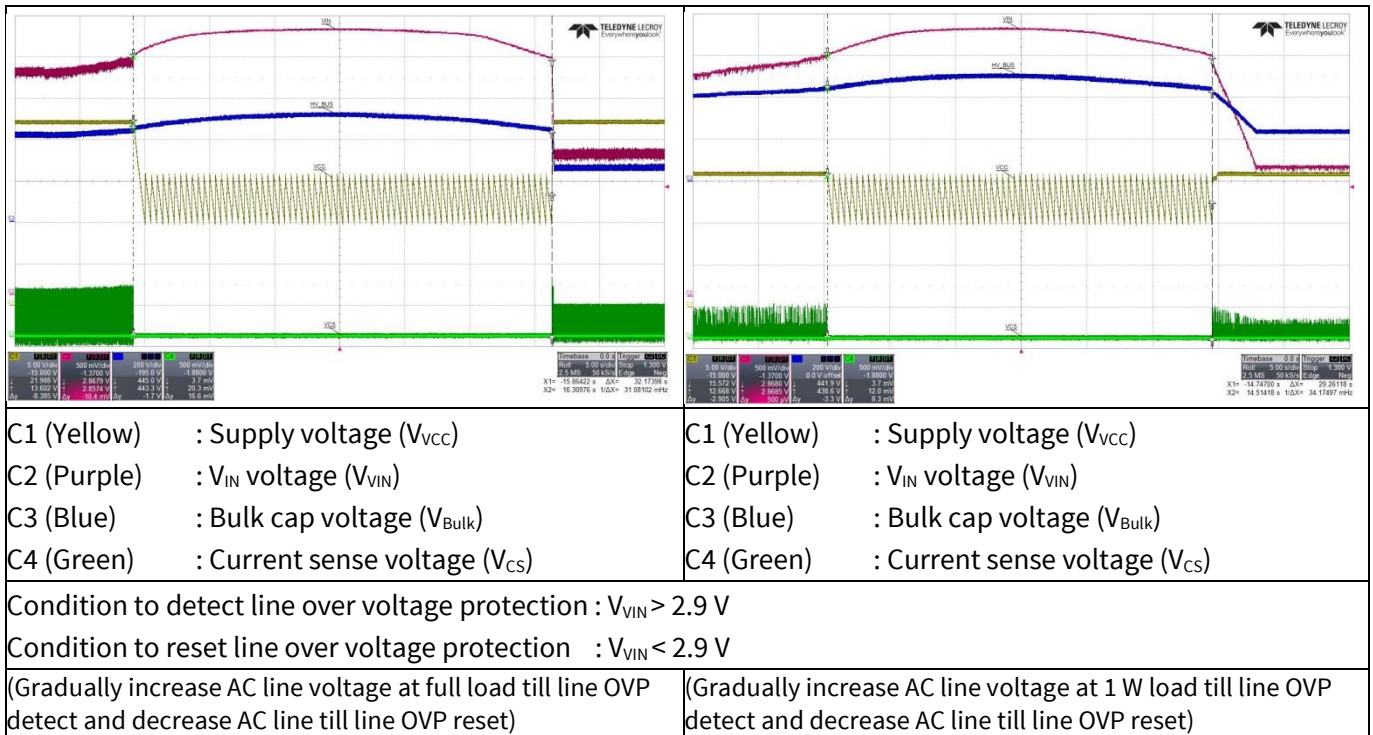

Figure 26 Line over voltage protection

11.12 Brownout protection (non switch auto restart)

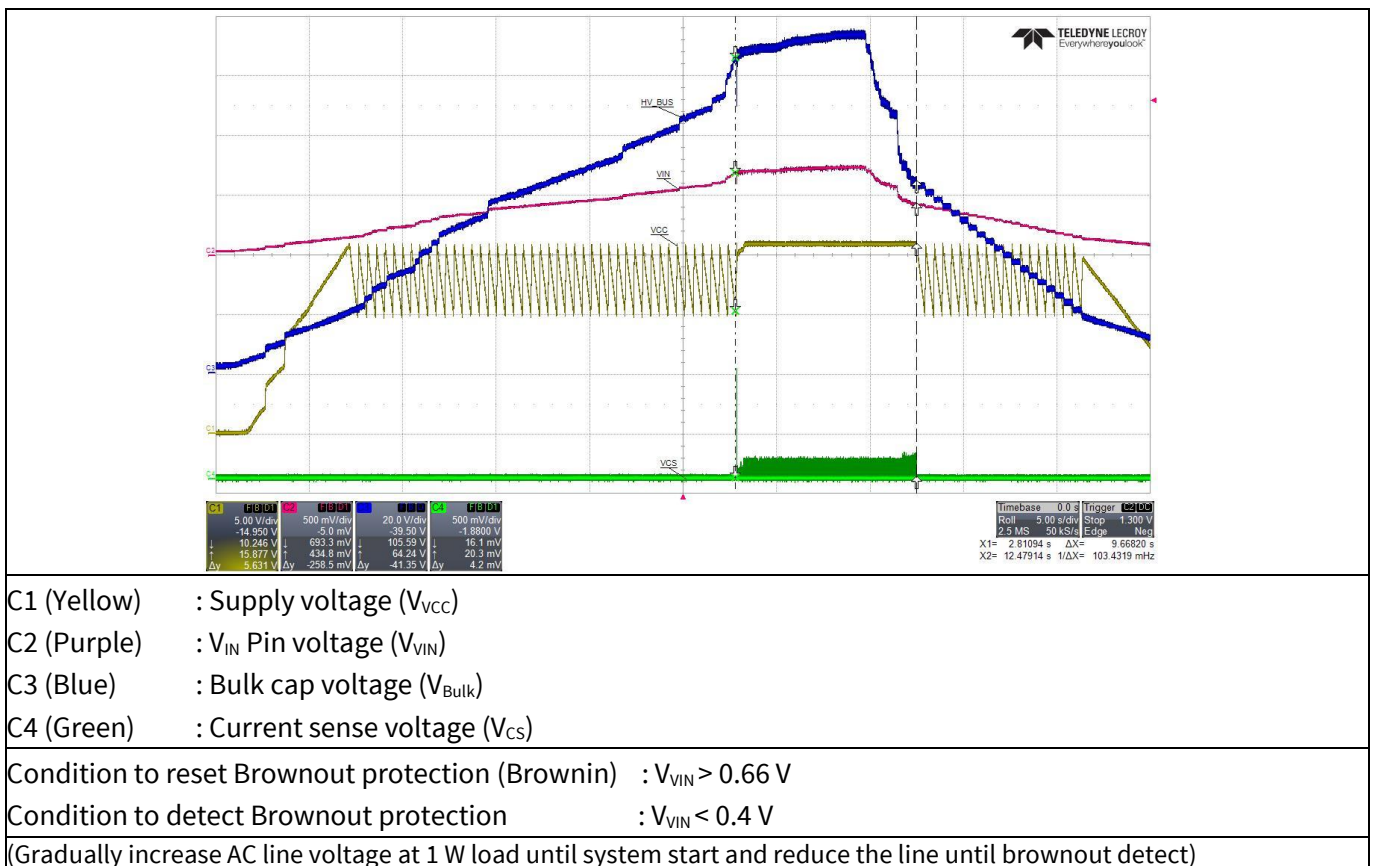
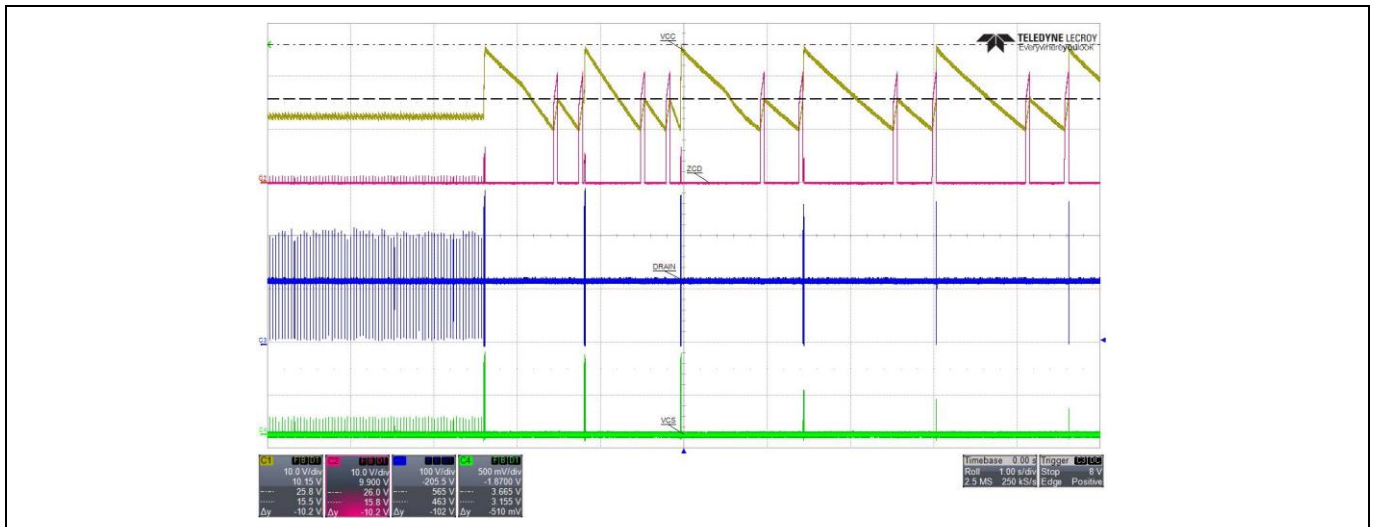

Figure 27 Brownout protection



Waveforms and oscilloscope plots

11.13 V<sub>CC</sub> over-voltage protection (odd skip auto restart)



- C1 (Yellow) : Supply voltage (V<sub>CC</sub>)
- C2 (Purple) : Zero crossing detection voltage (V<sub>ZCD</sub>)
- C3 (Blue) : Drain voltage (V<sub>D</sub>)
- C4 (Green) : Current sense voltage (V<sub>CS</sub>)

Condition to enter V<sub>CC</sub> over-voltage protection: V<sub>CC</sub> > 25.5 V  
 (85 V AC and disable ZCD pin output OVP detection, short R26)

Figure 28 V<sub>CC</sub> over voltage protection

11.14 V<sub>CC</sub> under voltage protection (auto restart)

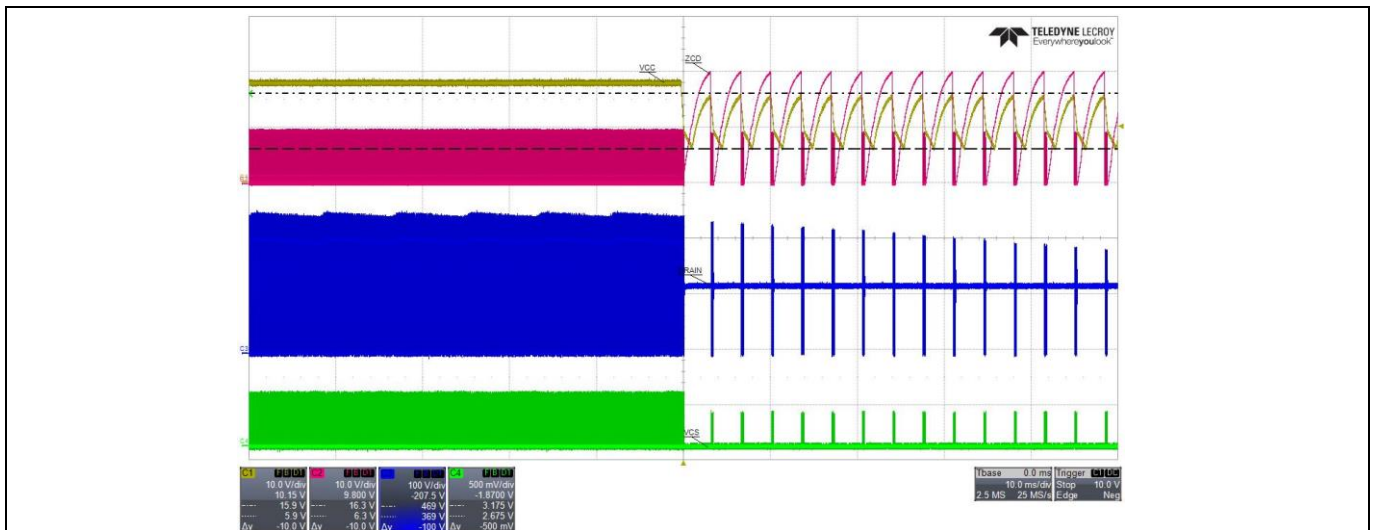

- C1 (Yellow) : Supply voltage (V<sub>CC</sub>)
- C2 (Purple) : Zero crossing detection voltage (V<sub>ZCD</sub>)
- C3 (Blue) : Drain voltage (V<sub>D</sub>)
- C4 (Green) : Current sense voltage (V<sub>CS</sub>)

Condition to enter V<sub>CC</sub> under voltage protection: V<sub>CC</sub> < 10 V  
 (Remove R12A during normal operation @ 85 V AC)

Figure 29 V<sub>CC</sub> under voltage protection

Waveforms and oscilloscope plots

11.15 Overload protection (odd skip auto restart)

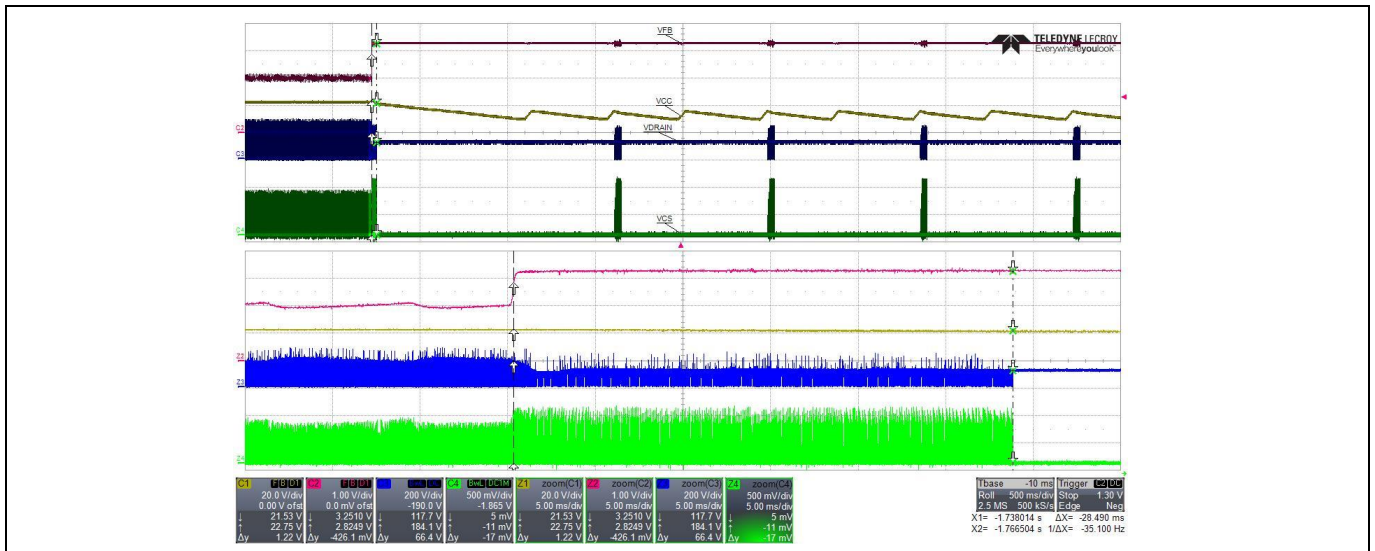

- C1 (Yellow) : Supply voltage ( $V_{CC}$ )
- C2 (Purple) : Feedback voltage ( $V_{FB}$ )
- C3 (Blue) : Drain voltage ( $V_D$ )
- C4 (Green) : Current sense voltage ( $V_{CS}$ )

Condition to enter over load protection:  $V_{FB} > 2.75\text{ V}$  & last for 30 ms blanking time  
 (12 V output load change from full load to short at 85 V AC)

Figure 30 Overload protection

11.16 Output over-voltage protection (odd skip auto restart)

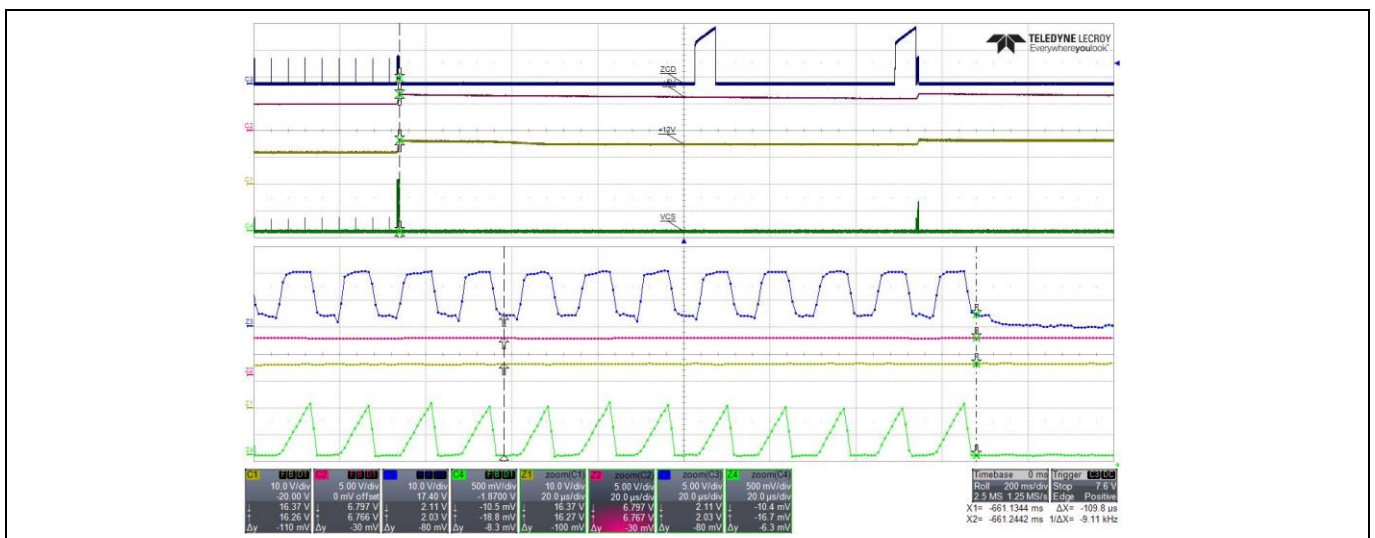

- C1 (Yellow) : 12 V output voltage ( $V_{O12}$ )
- C2 (Purple) : 5 V output voltage ( $V_{O5}$ )
- C3 (Blue) : Zero crossing detection voltage ( $V_{ZCD}$ )
- C4 (Green) : Current sense voltage ( $V_{CS}$ )

Condition to enter output OVP:  $V_{O12} > 17\text{ V}$ ,  $V_{O12} > 7\text{ V}$  ( $V_{ZCD} > 2\text{ V}$ )  
 (85 V AC, short R26 during system operation at no load)

Figure 31 Output over-voltage protection

Waveforms and oscilloscope plots

11.17 V<sub>CC</sub> short to GND protection

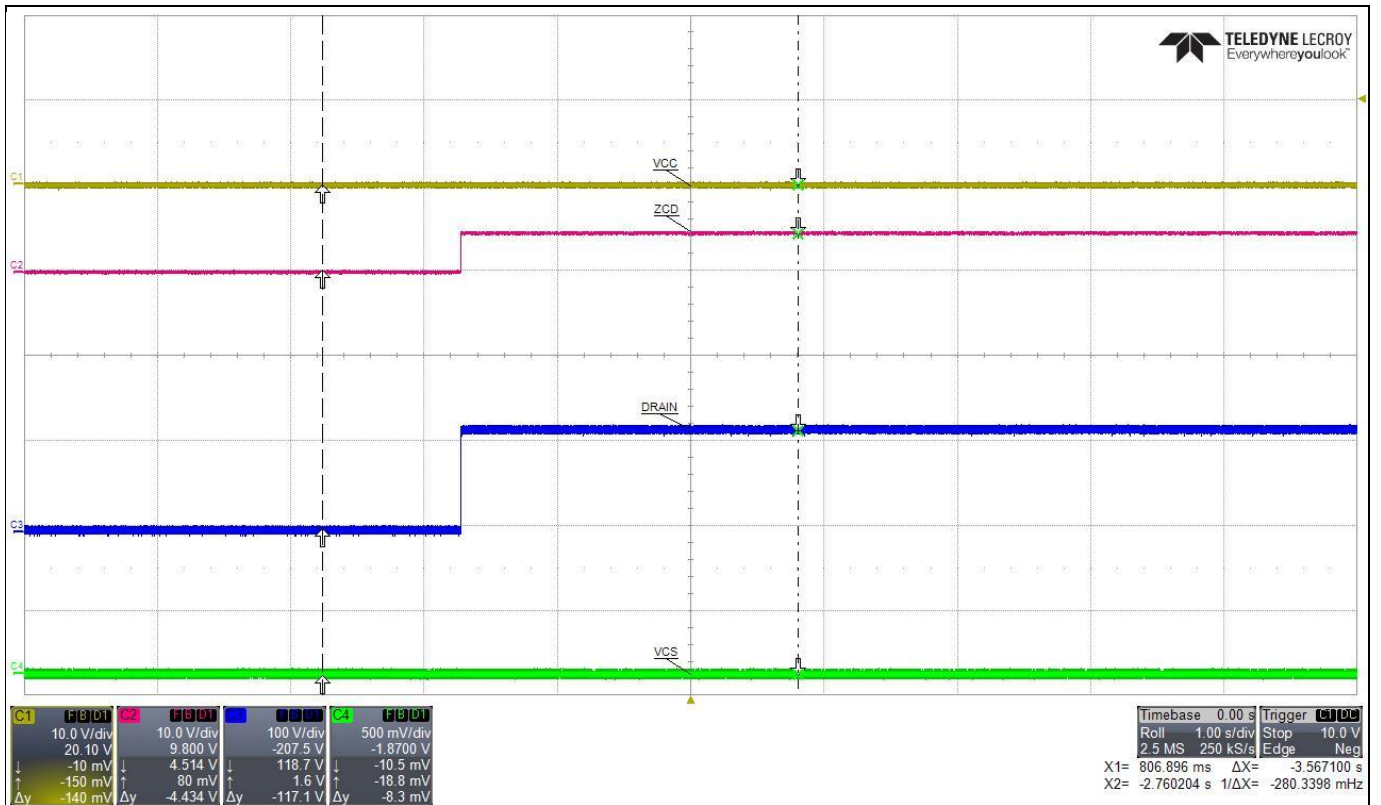

- C1 (Yellow) : V<sub>CC</sub> voltage (V<sub>VCC</sub>)
- C2 (Purple) : Zero crossing detection voltage (V<sub>ZCD</sub>)
- C3 (Blue) : Drain voltage (V<sub>D</sub>)
- C4 (Green) : Current sense voltage (V<sub>CS</sub>)

Condition to enter V<sub>CC</sub> short to GND : if V<sub>CC</sub> < V<sub>VCC\_SCP</sub> → I<sub>VCC</sub> = I<sub>VCC\_Charge1</sub>  
 (Short V<sub>CC</sub> pin to GND by multi-meter and measure the current, I<sub>VCC</sub> ≈ 280 μA and input power is ≈ 52 mW at 85 V AC and full load)

Figure 32 V<sub>CC</sub> short to GND protection

---

**References****12 References**

- [1] [ICE5QRxxxxAx datasheet, Infineon Technologies AG](#)
- [2] [AN-201609 PL83 026-5<sup>th</sup> Generation Quasi-Resonant Design Guide](#)
- [3] [Calculation Tool Quasi-Resonant CoolSET™ Generation 5](#)

**Revision history****Major changes since the last revision**

| Page or reference | Description of change |
|-------------------|-----------------------|
| --                | First release.        |
|                   |                       |
|                   |                       |

#### Trademarks of Infineon Technologies AG

AURIX™, C166™, CanPAK™, CIPOS™, CoolGaN™, CoolMOS™, CoolSET™, CoolSiC™, CORECONTROL™, CROSSAVE™, DAVE™, DI-POL™, DrBlade™, EasyPIM™, EconoBRIDGE™, EconoDUAL™, EconoPACK™, EconoPIM™, EiceDRIVER™, eupec™, FCOS™, HITFET™, HybridPACK™, Infineon™, ISOFACE™, IsoPACK™, i-Wafer™, MIPAQ™, ModSTACK™, my-d™, NovalithIC™, OmniTune™, OPTIGA™, OptiMOS™, ORIGA™, POWERCODE™, PRIMARION™, PrimePACK™, PrimeSTACK™, PROFET™, PRO-SIL™, RASIC™, REAL3™, ReverSave™, SatRIC™, SIEGET™, SIPMOS™, SmartLEWIS™, SOLID FLASH™, SPOC™, TEMPFET™, thinQ!™, TRENCHSTOP™, TriCore™.

Trademarks updated August 2015

#### Other Trademarks

All referenced product or service names and trademarks are the property of their respective owners.

**Edition 2017-05-24**

**Published by**

**Infineon Technologies AG**

**81726 Munich, Germany**

**© 2017 Infineon Technologies AG.**

**All Rights Reserved.**

**Do you have a question about this document?**

**Email: [erratum@infineon.com](mailto:erratum@infineon.com)**

**Document reference**

**AN\_201611\_PL83\_002**

#### IMPORTANT NOTICE

The information contained in this application note is given as a hint for the implementation of the product only and shall in no event be regarded as a description or warranty of a certain functionality, condition or quality of the product. Before implementation of the product, the recipient of this application note must verify any function and other technical information given herein in the real application. Infineon Technologies hereby disclaims any and all warranties and liabilities of any kind (including without limitation warranties of non-infringement of intellectual property rights of any third party) with respect to any and all information given in this application note.

The data contained in this document is exclusively intended for technically trained staff. It is the responsibility of customer's technical departments to evaluate the suitability of the product for the intended application and the completeness of the product information given in this document with respect to such application.

For further information on the product, technology, delivery terms and conditions and prices please contact your nearest Infineon Technologies office ([www.infineon.com](http://www.infineon.com)).

#### WARNINGS

Due to technical requirements products may contain dangerous substances. For information on the types in question please contact your nearest Infineon Technologies office.

Except as otherwise explicitly approved by Infineon Technologies in a written document signed by authorized representatives of Infineon Technologies, Infineon Technologies' products may not be used in any applications where a failure of the product or any consequences of the use thereof can reasonably be expected to result in personal injury.